

### KEY FEATURES

- Designed for compression drivers with 1.4" mouth diameter
- It provides uniform response, on and off-axis with a neutral and natural frequency reproduction
- Coverage angles of 90° in the horizontal plane and 40° in the vertical plane
- Straightforward mounting thanks to its plane mouth finish



### GENERAL DESCRIPTION

This 1.4" throat entry horn has been designed in order to provide uniform on and off-axis frequency response, with uncoloured and natural sound reproduction. The constant directivity characteristics of this model ensure the ability to cover 90° wide horizontally and 40° wide vertically, at virtually any frequency within its operational range. Since the response remains essentially constant, equalisation is easily simplified. To ensure freedom of resonance, this flare is constructed of high-density rigid polyurethane foam, with flat front finish to facilitate flush mounting, and an aluminium adaptor for precise pattern control.

### TECHNICAL SPECIFICATIONS

<b>Throat diameter</b>	36 mm. 1.4 in.
<b>Horizontal beamwidth</b>	90° (+4° -30°) (-6dB, 0.63 - 16 kHz)
<b>Vertical beamwidth</b>	40° (+22° -9°) (-6dB, 1.6 - 16 kHz)
<b>Directivity factor (Q)</b>	12.5 (average 0.63 - 16 kHz)
<b>Directivity index (DI)</b>	11 dB (+2.6 dB, -3.2 dB)
<b>Cutoff frequency</b>	800 Hz
<b>Dimensions</b>	W x H x D: 250 x 280 x 220 mm.
<b>Cutout dimensions</b>	W x H: 215 x 245 mm.
<b>Net weight</b>	1.2 kg.
<b>Shipping weight</b>	2 kg.

#### Construction

Rigid polyurethane foam.

Aluminium adaptor.

Connection of driver by four screws on a 4 in (101.6 mm.) diameter bolt circle.

Mounting hardware is supplied.

### DIMENSION DRAWINGS

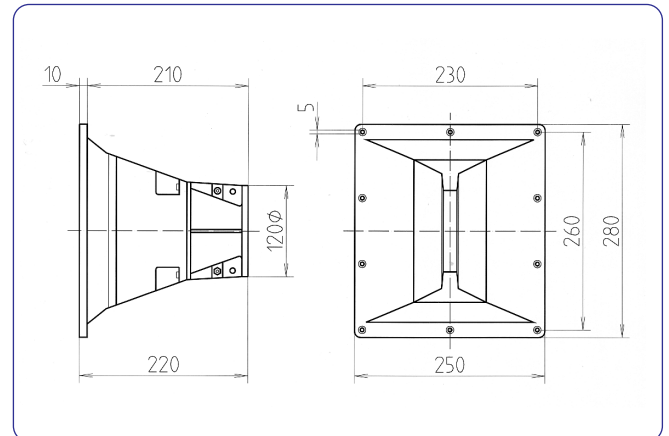

### -6dB BEAMWIDTH\*

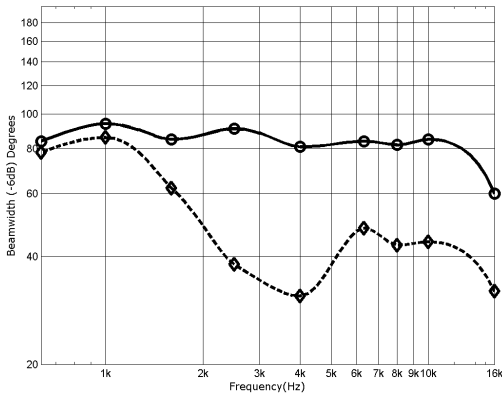

### DIRECTIVITY

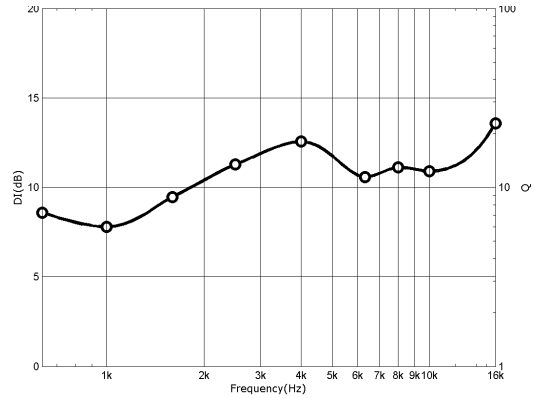

### POLAR RESPONSE\*\*

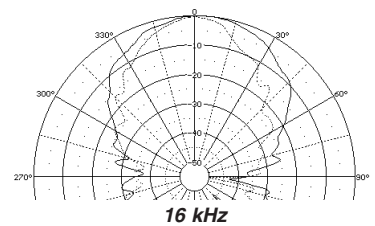
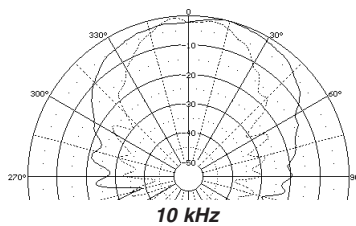
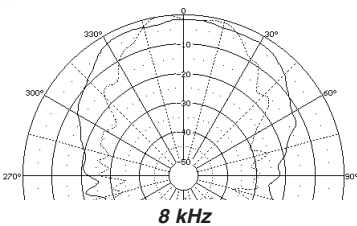
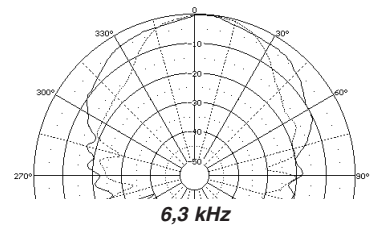
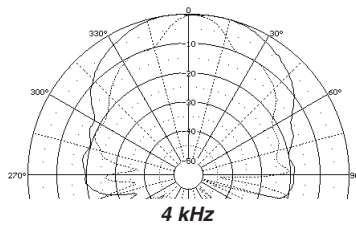
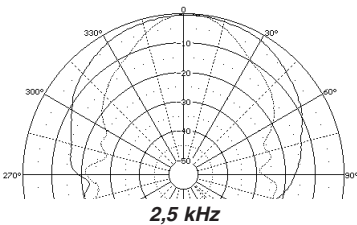
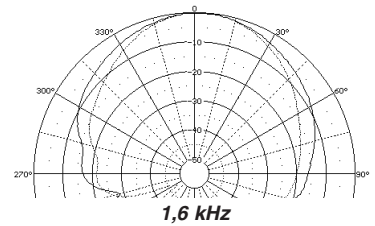
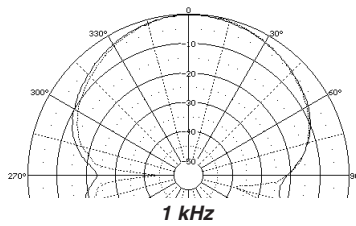
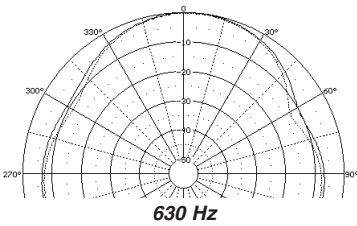

**NOTES.**

\* Horizontal beamwidth is represented by the heavy line. Vertical beamwidth is represented by the discontinuous line.

\*\* Horizontal response is represented by the heavy lines. Vertical response is represented by the discontinuous lines. The polar plots are reproduction of measurements done with single sinusoidal signal tones, at the indicated frequencies. The microphone was placed 2 m from the horn, and rotation was about the centre of the emitter source.



acústica beyma, s.a.