

Poignées de transport

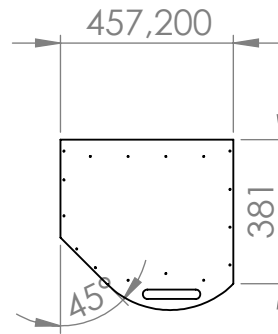

Emplacement RCF HF64 + ND650

Emplacement RCF L15P540

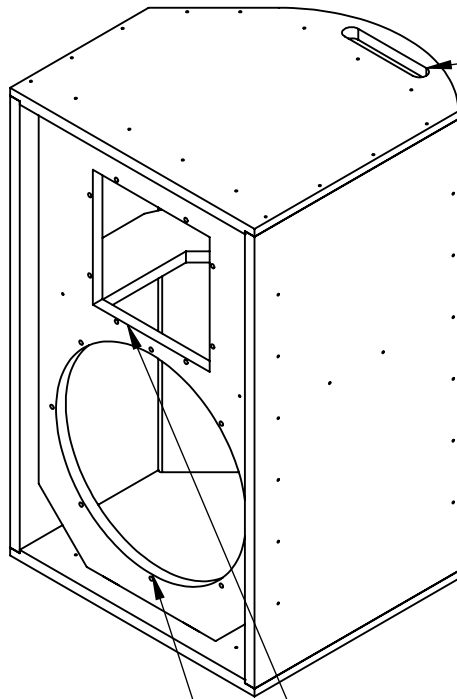
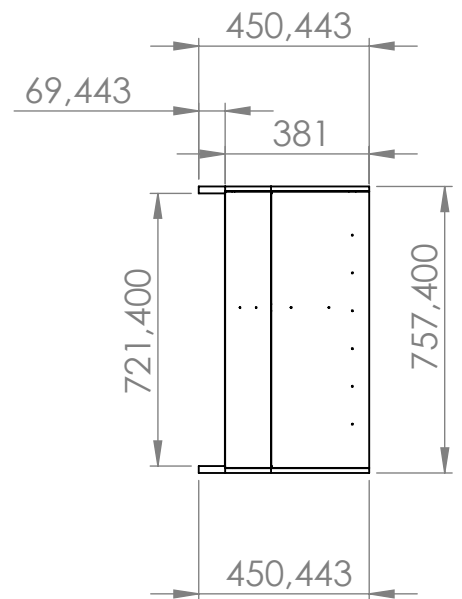
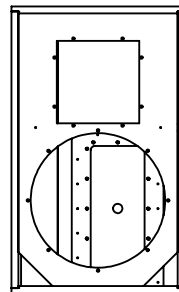
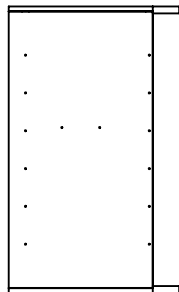
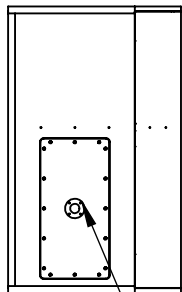

Pour intégration NL4MPR

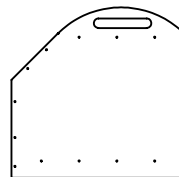

# RCF CLUB15HP