

8 pockets ø9 - depth 17

MATERIALE: 19mm MDF - transmission walls  
25mm MDF - cabinet and base

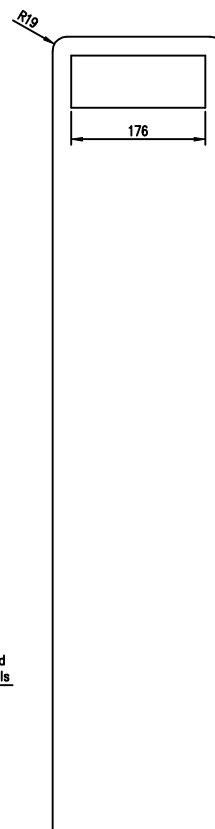

BASE

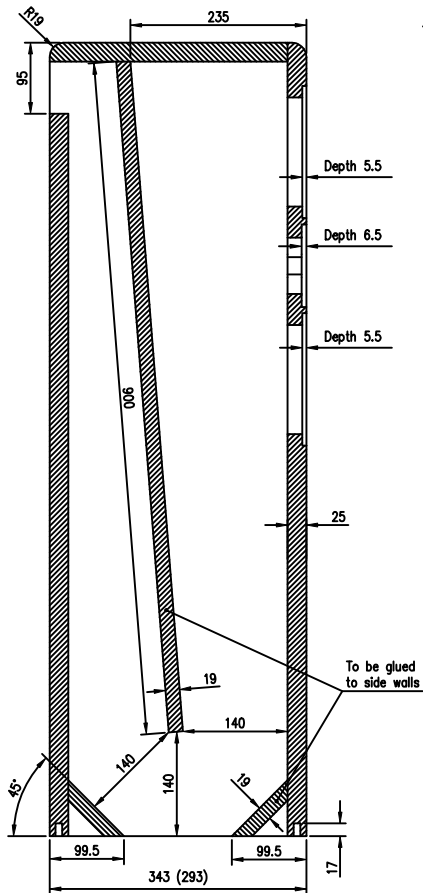
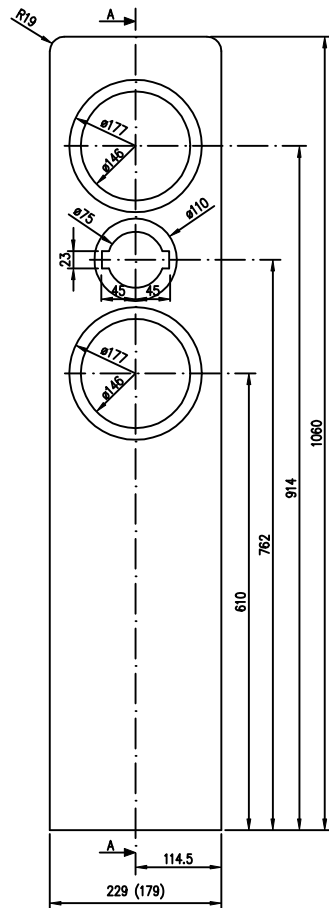
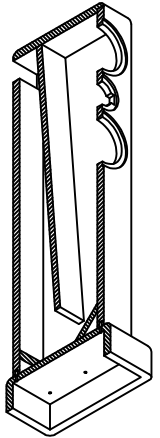
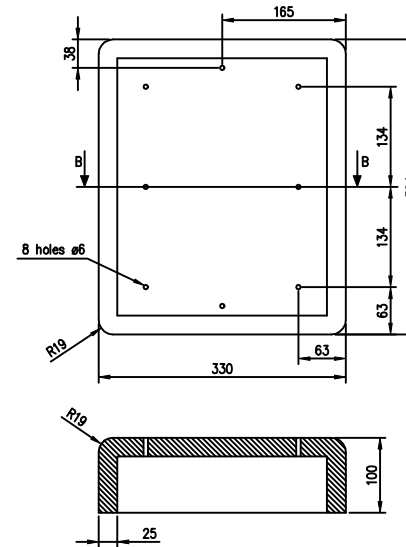

Ingeniør Tegner Kontrolleret Godkjent Målestokk	SP								
	Antall	Benevnelse	Nr.	Tegn.nr.	Matr.	Bemærkning			
	Dato	Sign.	<b>seas</b> FABRIKKER A.S.						
	Tegnet	02.01.2001							
Målestokk	1:5		CABINET THOR			K00218			
Erstatning for:						Erstattet av:			

# CROSSOVER NETWORK for THOR and ODIN Mk3

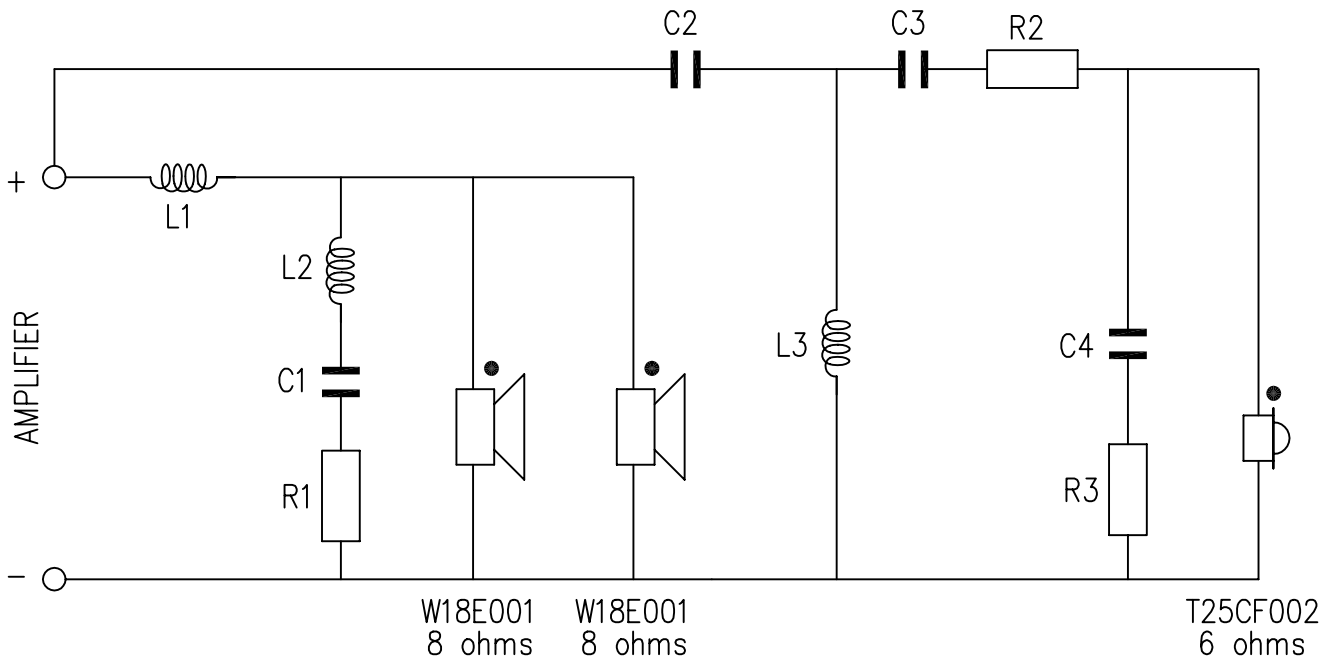

COILS	CAPACITORS	RESISTORS
L1=1,00mH - ø1.63mm (#14AWG)	C1 = 8,2µF	R1 = 0,5 ohms
L2=0,15mH - ø0,81mm (#20AWG)	C2 = 8µF	R2 = 2,0 ohms
L3=0,24mH - ø0,81mm (#20AWG)	C3 = 18µF	R3 = 12,5 ohms
Air-core	C4 = 2,2µF	Metalic oxide or non-inductive wire wound
	Polypropylene or polyester foil	

ESC End

D S A Frequency Response

Mac i 03.07.101 09:41

Distance Loudsp.- Mic.: 104.6cm dB SPL normalised on 1 Meter Delay: 3.1ms

MO: THOR

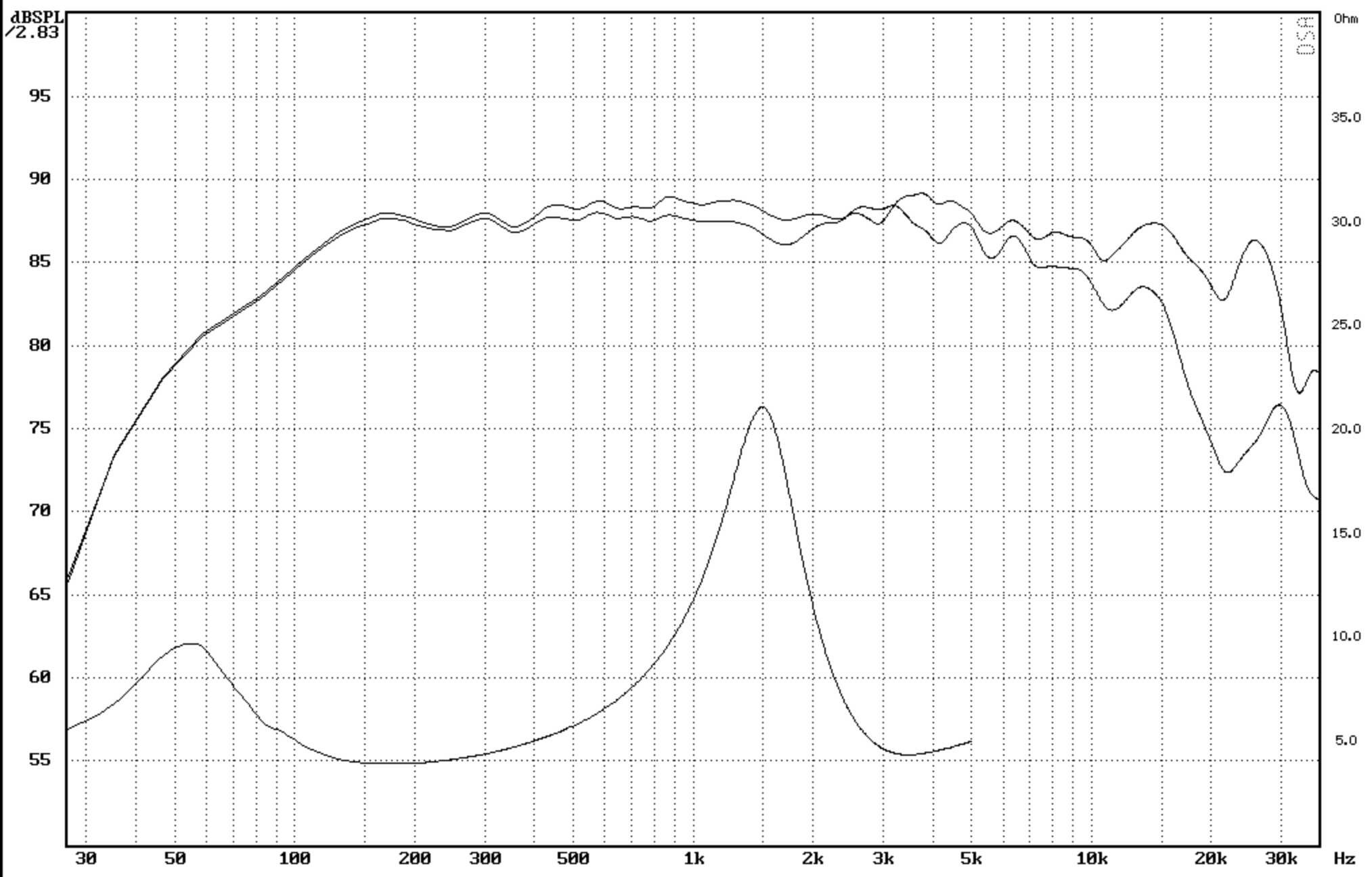

# THOR: A D'Appolito Transmission Line

With this exceptional design for some exceptional drivers by an exceptional designer, transmission-line ownership is well within your grasp.

By Joe D'Appolito

**D**uring CES 2000 I met with Norwegian and US representatives of SEAS. They described their new Excel line of drivers to me and asked whether I could design a flagship loudspeaker using these drivers that would highlight their extraordinary capabilities. They wanted something other than a vanilla sealed or vented box.

I suggested a transmission line, pointing out that the non-resonant behavior of this enclosure assured that we would hear the full capabilities of these drivers free of “boxy” coloration. The SEAS folks agreed enthusiastically, and the THOR transmission-line project was born.

## THE THOR-EXCEL TRANSMISSION-LINE LOUDSPEAKER

Transmission-line (TL) loudspeakers have long enjoyed a small but dedicated following, especially in the DIY community. The advantages of TLs are well known. They are essentially non-resonant enclosures, producing a deep, well-controlled bass response. For a given driver, bass response can often extend well below that produced with either a vented or sealed enclosure using the same driver. Above a few hundred Hz, the line-filling material completely absorbs the driver back wave, giving the TL an open, non-boxy sound.

Unfortunately, the TL has not enjoyed wide commercial popularity due to the lack of a good design theory and the additional complexity of enclosure fabrication relative to the more conventional vented and sealed enclosures. Recently, however, work by G.L. Augspurger has appeared in the techni-

cal literature<sup>1</sup> and in *audioXpress*<sup>2,3,4</sup> that, while not providing a complete theory of design, has given us an excellent starting point. This, coupled with modern PC-based acoustic measurement systems, allowed me to converge quickly to an optimum design for the new Excel W18EX001 woofers.

The present design uses an MTM driver configuration in a tapered, folded line uniformly filled with Dacron pillow stuffing. Tapering the line greatly increases the frequency range of bass augmentation produced by the line. Using two mid-bass drivers exciting the line at slightly different points reduces mid-bass ripple.

The resulting line produces a uniform 3–4dB bass response lift from 110Hz all the way down to 20Hz with less than 1dB ripple. The –3dB point is 44Hz. Contrast this against 65Hz for a similarly

damped sealed enclosure. Below 45Hz TL bass response falls off at 12dB per octave, compared to the 24dB/octave fall-off rate of a vented system. In most rooms useful bass response extends well down into the 30Hz region.

Above 2500Hz the system crosses over to an Excel T25CF002 tweeter. Several hundred hours of laboratory testing and listening have gone into producing a seamless transition between the mid-bass and tweeter drivers. You literally cannot tell where the woofers leave off and the tweeter begins.

The Excel product line from SEAS was introduced in 1994 as a showcase for the company's best ideas and technologies. Originally comprised of only five models, the Excel line has expanded to ten products, with additional designs in continuous development.

## THE W18E001 WOOFER

Building a “better” mid/woofer required a complete rethinking of nearly every component in the driver: the cone, the magnet system, the surround, and the basket.



PHOTO 1: In the lab, ready to test and trim the line.

## The Magnesium Cone

The advantages of metal cones are well known. They remain virtually pistonic throughout their passband, and do not suffer from midband cone edge resonance problems so common in paper and other soft cones. Prior to the development of the magnesium cone, virtually all metal cones used some form of aluminum alloy. While aluminum is an easy material to form either by stamping or spinning, it also suffers from its share of acoustic drawbacks.

To keep the moving mass reasonably low, the cone must be quite thin. For an 18cm woofer, the nominal thickness is approximately .18mm. This, unfortunately, results in a cone with numerous high Q breakup modes starting at about 5kHz and extending beyond 10kHz.

SEAS therefore decided to search for a material with a potential for greater stiffness than aluminum. Magnesium was attractive because its specific gravity was only 1.7 versus 2.7 for aluminum. This meant that, for the same cone mass, a magnesium diaphragm could contain almost 60% more material by volume than aluminum. This gave the potential for much greater stiffness and internal damping of the cone with no increase in mass. Acoustic testing of prototype magnesium cones immediately revealed the benefits over the aluminum cone: the breakup modes had been largely reduced to a single, well-defined peak that could easily be suppressed via simple notch filtering.

The question was how to produce the cone? Magnesium does not lend itself to bending or shaping in the thickness required for a loudspeaker cone. That left the only option of die-casting. Fortunately, a small magnesium foundry

close to the factory was able to cast the rough cone. But getting to the finished cone would require that the remaining processes be developed in-house.

SEAS developed a special machining process to remove the precise amount of material necessary to shape the cone and achieve the proper mass. Through much experimentation, a cone of varying thickness between .26mm and .33mm was found to be the ideal solution.

All that remained was the finishing process to give the cone an attractive look and prevent it from corroding over time. For this, a chemical etching process was developed, followed by a coat of protective lacquer on the front and rear surface, giving the cone its unique appearance.

## The Excel Motor

To gain the greatest advantage from the magnesium cone, an exceptional magnet system was required. The key design goals of the Excel motor were to: 1) Reduce the levels of eddy current distortion and flux modulation, thereby reducing harmonic and intermodulation distortion, 2) Stabilize the inductance of the voice coil under all excursion conditions to reduce modulation distortion, and 3) Improve the heat transfer from the coil and pole piece to the outside air to reduce voice-coil temperature and subsequent voltage sensitivity modulation.

These goals were accomplished by incorporating two heavy copper rings fitted above and below the magnet gap defined by a T-shaped pole piece, which was press-fit into a bumped back plate. To further enhance the heat transfer capability, a solid copper phase plug was fitted to the top of the upper ring. The

stationary phase plug replaces a conventional dust cap and thereby eliminates the acoustic resonator behind the dust cap. At the same time, the excellent thermal conductivity of the phase plug aids tremendously in heat dissipation, while the air movement from the cone over the phase plug also serves to cool the motor.

## The Excel Basket

A high-performance motor and cone should not be mechanically or acoustically limited by a less than optimal basket. For the W18E001, an entirely new state-of-the-art, die-cast zinc basket was developed. The casting is extremely stiff, maintaining precise alignment of all mechanical parts, and providing a stable and secure mounting surface for the cabinet.

At the same time the rear of the basket is designed to be as open as possible, using thin but strong "arms" that minimize early reflections at the rear of the cone. The area behind the spider is completely open as well, eliminating air compression and "chuffing noise."

Complete specifications for the Excel woofer are listed in *Table 1*.

## WHICH TL GEOMETRY?

After describing the performance of straight TLs in the first two parts of his series for *Speaker Builder*, Augspurger details five alternate geometries in Part 3<sup>4</sup> that provide certain benefits over a straight pipe. Of these, two will be used in the THOR system, and the benefits of a third will be obtained by alternate means. The particular geometries are the tapered line, the offset driver line, and the coupling chamber line. The benefits of each are as follows.

1. Tapering the line broadens its fundamental resonance and thereby increases the frequency range of constructive pipe output. The  $f_3$  value is typically 0.8 times  $f_p$ . Attenuation of upper harmonics is comparable to a straight line. Augspurger recommends tapers in the range of 3:1 to 4:1.

2. Offsetting the driver from the closed end of the line by one-fifth its length reduces the first passband dip, thus smoothing low-frequency response. However,  $f_3$  must be set about 20% higher than  $f_p$  for the flattest response.

TABLE 1  
EXCEL WOOFER SPECIFICATIONS

Nominal impedance	8Ω	Voice coil resistance	6.1Ω
Frequency range	40–2500Hz	Voice coil inductance	0.4mH
Short-term maximum power	250W*	Bl factor	7.2N/A
Long-term maximum power	100W*	Free-air resonance	31Hz
Characteristic sensitivity	86.5dB SPL	Moving mass	15.5g
Voice-coil diameter	39mm	Suspension compliance	1.6mm/N
Voice-coil height	16mm	Suspension resistance	1.4Ns/m
Air gap height	6.0mm	Effective cone area	126cm <sup>2</sup>
Linear coil travel (p-p)	10.0mm	V <sub>AS</sub>	37.0 ltr
Magnetic gap flux density	0.88T	Q <sub>MS</sub>	2.5
Magnet weight	0.42kg	Q <sub>ES</sub>	0.39
Total weight	1.75kg	Q <sub>TS</sub>	0.34

\*IEC 268-5

3. A coupling chamber between the driver and the pipe inlet lowers the fundamental frequency of the combination. The coupling chamber compliance combines with the resistive acoustic impedance of the damped line to produce a first-order low-pass filter that increases high-frequency attenuation.

It was clear to me at the outset that I wanted to use a tapered line to get a

low  $f_3$  with fairly broad low-frequency reinforcement. Additionally, with the MTM driver configuration one driver is automatically offset from the closed end of the line. This driver offset will mitigate somewhat against the low-frequency extension provided by the taper, but will help to reduce midbass response ripple.

Finally, folding the line provides additional high-frequency attenuation,

somewhat like that obtained with the chambered line. With these considerations in mind, I describe the initial layout and sizing of the THOR TL.

### SIZING THOR

A big advantage of sealed and vented box design is that Thiele and Small, among others, have established strict relationships between driver parameters and box volume and, in the case of vented designs, box tuning, for a specified frequency response. This greatly simplifies the design process for these systems.

TABLE 2  
EXCEL TWEETER SPECIFICATIONS

Nominal impedance	6Ω	Voice coil resistance	4.7Ω
Frequency range	2–25kHz	Voice-coil inductance	0.05mH
Short-term maximum power	200W*	Bl factor	3.1N/A
Long-term maximum power	90W*	Free air resonance	500Hz
Characteristic sensitivity	88dB SPL	Moving mass	0.37g
Voice-coil diameter	26mm	Linear voice coil travel	1.0mm
Voice-coil height	1.5mm	Effective piston area	7cm <sup>2</sup>
Air gap height	2.5mm	Magnet weight	29g
Magnetic gap flux density	0.88T	Total weight	0.36kg

\*IEC 268-5 using 12dB/octave Butterworth high-pass filter at 2500Hz

TABLE 3

Design	$Q_{TS}$	$f_3/f_S$	$f_S/f_D$	$V_{AS}/V_D$
Tapered	0.33	1.6	0.50	1.00
(Nom. 4:1)	0.35	1.525	0.533	0.90
	0.41	1.3	0.63	0.60
Offset	0.33	1.6	0.74	1.00
Speaker	0.35	1.525	0.80	0.90
	0.41	1.3	0.94	0.60

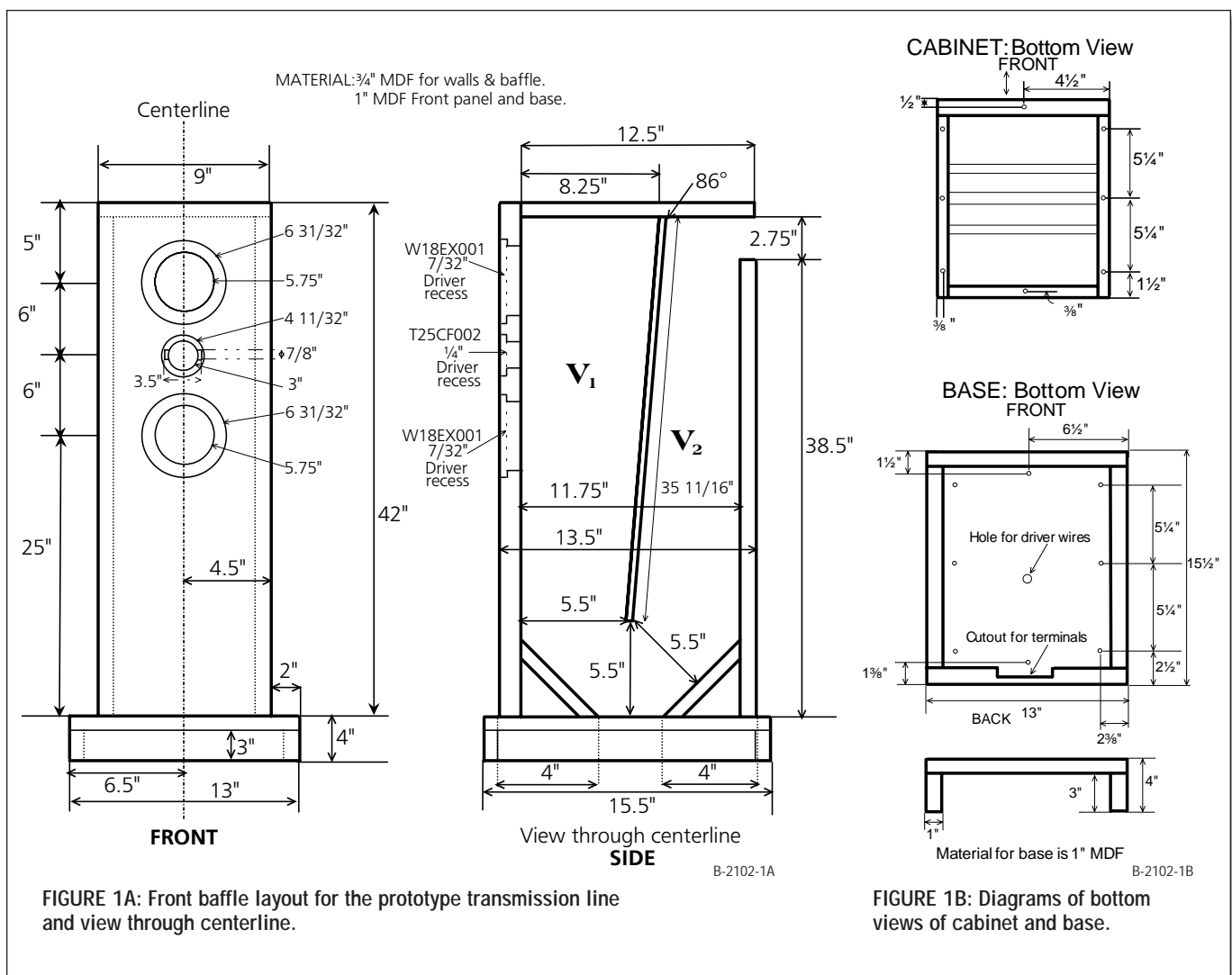



## Subscribe to *audioXpress* for:

**Projects**—including schematics, parts lists, photos, construction details, sources—everything you need to get right to building.

**Technology**—theory & knowledge to improve your capabilities to build great sounding equipment

**Reviews**—previews of kits—do you want to build it? Previews of products—does it perform as the manufacturer states? Previews of books and software—Is this information you want?

**Letters, Tips, & Techniques**—Read questions, clarifications, debates, tips, and reader comments to learn even more from each article. As a subscriber, you're instantly part of a community of thousands of audio craftsmen like yourself.

**Easy-access to information**—*audioXpress* is written for you with an easy-to-read table of contents and regular departments focused on specific areas of audio technology.

**Information you can depend on**—the knowledge presented and the quality of articles presented in *audioXpress* is unparalleled. You'll be treated to articles by experts in their fields including Douglas Self, Nelson Pass, G R Koonce, and many others from our cadre of over 700 authors.

12 monthly issues for only

**\$34.95!**

That's less than **\$3.00** per issue for all this!

Canada add \$12. Overseas rate: \$59.95 for 1 year.

Call **1-888-924-9465**

to request your first issue

**FREE TO TRY**

or e-mail: [custserv@audioXpress.com](mailto:custserv@audioXpress.com)!

**audioXpress**

PO Box 876 Dept. MDR,  
Peterborough, NH 03458-0876 USA  
Phone: 603-924-9464 Fax: 603-924-9467

[www.audioXpress.com](http://www.audioXpress.com)



The significance of Augspurger's work is that for the first time we now have relationships between the driver parameters  $f_s$ ,  $Q_{TS}$ ,  $V_{AS}$ , and the TL frequency,  $f_p$ , and volume,  $V_p$ . Strictly speaking, his relationships are not

unique, but they do represent an excellent starting point and give us confidence that a good design can be attained.

The starting point for TL sizing is Augspurger's table of extended system

alignments given in Part 3 of his series. Portions of that table are reproduced here in *Table 3*. These alignments are optimum in the sense that they approximate the response of an equal volume closed box, but with reduced cone ex-

## EXCEL MILLENNIUM TWEETER

The history of dome tweeter development at SEAS has been a long and successful one, going back more than 30 years. SEAS' first dome tweeter was also one of its best known and most produced. This was the original type H087, 1½" dome tweeter, used in the legendary Dynaco A25 loudspeaker. This landmark loudspeaker, manufactured by SEAS, was sold in the hundreds of thousands, and served as many a budding audiophile's introduction to true high-fidelity sound.

Producing the early dome tweeters was labor intensive, and considerable skill on the assembly line was required to produce a product with consistent quality. A sticky "doping compound," used to both seal and damp the dome diaphragm, was applied by hand after the tweeter was assembled. Obviously, the amount of the material and the evenness of application were critical to obtaining the desired frequency response.

Since those first designs, much research has been done to simplify and stabilize the process for producing soft domes. Other, non-cloth materials, such as supronyl (polyamid) plastic, were successfully used as substitutes. But these, too, were far from ideal, because their performance was highly dependent on ambient humidity and temperature. By the late 1980s, promising new cloth materials were becoming available which allowed the cloth to be treated prior to forming the dome. In this way, the advantages of cloth could be realized without the need to coat the dome after assembly.

Today, SEAS manufactures all of its dome diaphragms in house, using special vacuum-forming equipment also designed and built by SEAS. Cloth diaphragms are produced from a proprietary material called "SONOTEX®." The SONOTEX process pre-coats the fabric four times with a damping/sealing material, giving a nearly ideal combination of acoustic performance and high consistency.

For the Millennium tweeter, SEAS designed a special two-piece diaphragm consisting of a SONOTEX dome with a SONOMAX® plastic surround. This combination results in a diaphragm with very linear behavior and large excursion capability.

### THE HEXADYM® MAGNET SYSTEM

The ceramic-magnet-based magnet system found in most tweeters

has remained basically unchanged for many years. The tweeter's magnet system performs two separate functions:

1. Supply the proper amount of magnetic flux to the voice coil
2. Allow the acoustic energy generated from the rear of the dome, the surround, and the voice coil to be fully absorbed within the tweeter body without reflections, resonance, or pressure build-up.

Ceramic magnet systems are easily able to supply the necessary magnetic energy. But they also get in the way of the rearward radiated energy. The construction of the system with a ring magnet covered by top and back plates produces a large cavity in the area between the pole piece and the inside of the magnet.

This cavity, when excited by the movement of the voice coil, produces resonance and pumping effects that will directly impact the performance of the tweeter. Another secondary cavity sits between the dome surround and the magnet system's top plate. With such an enclosed ceramic system, the energy build-up directly behind the vibrating surround cannot be vented away from the magnet system's top plate.

The new, patented Hexadym magnet system in the Excel Millennium tweeter completely eliminates any enclosed cavities within the tweeter structure (*Photos A and B*). Instead of a single ring magnet, the Hexadym system uses six radially magnetized neodymium bar magnets mounted on a hexagonal pole piece. This compact configuration produces large openings around the pole piece, allowing virtually all air movement generated by the diaphragm and voice coil to be vented directly into the rear chamber. The Hexadym magnet system also allows airflow produced directly behind the dome's surround to be vented into the rear chamber through four generous openings in the top plate.

The mechanical construction of the Millennium tweeter also reflects the no-compromise approach used in the dome and magnet assemblies. The front plate and rear chamber are constructed of extremely rigid, die-cast zinc. This provides a virtually non-resonant enclosure for the tweeter, while simultaneously conducting heat away from the magnet system. —*John Stone*



PHOTO A: The Hexadym magnet system, bottom view.



PHOTO B: Hexadym pole piece, top view.

cursion when the damping is adjusted for a  $\pm 1$ dB passband ripple. Fortunately, the TL is a non-resonant system so that the optima are broad. As you will shortly see, significant departure from the alignments Augspurger recommends can be made with little loss of performance.

The driver parameters needed to enter *Table 3* are  $f_S$ ,  $Q_{TS}$ , and  $V_{AS}$ . Values of those parameters for the Excel W18E001 woofer are given in *Table 1*.

The line  $Q_{TS} = 0.35$  (which includes the effect of the crossover coil resistance on driver  $Q$ ) in *Table 3* has been interpolated from the  $Q_{TS}$  values of 0.33 and 0.41 given in Augspurger's *Table 2* of reference [4]. Notice that the columns headed  $f_3/f_S$  and  $V_{AS}/V_p$  are the same for both the tapered and offset speaker configurations for the same  $Q_{TS}$ . Thus  $f_3$  and  $V_p$  will be the same for both, but the line lengths will differ.

From *Table 3*, the predicted  $f_3$  is:

$$f_3 = 1.525f_S = 1.525 \times 31\text{Hz} = 47.3\text{Hz}$$

For the tapered line,  $f_p$  is calculated to be:

$$f_{pT} = \frac{f_S}{0.533} = \frac{31}{0.533} = 58.2\text{Hz}$$

The line length,  $L_p$ , is then one quarter

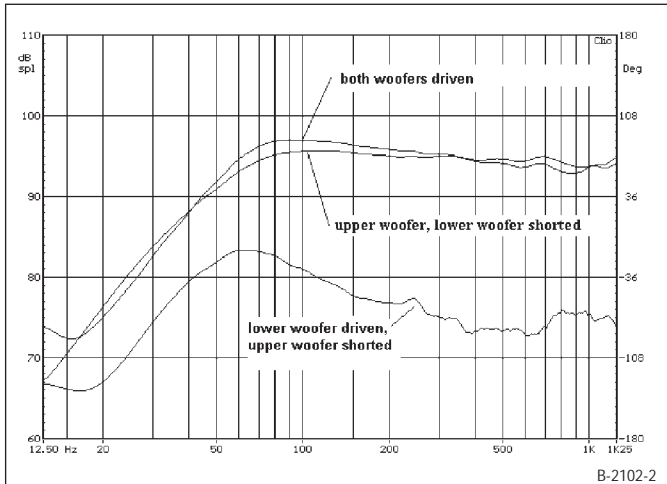

FIGURE 2: Near-field measurements on an MTM speaker.

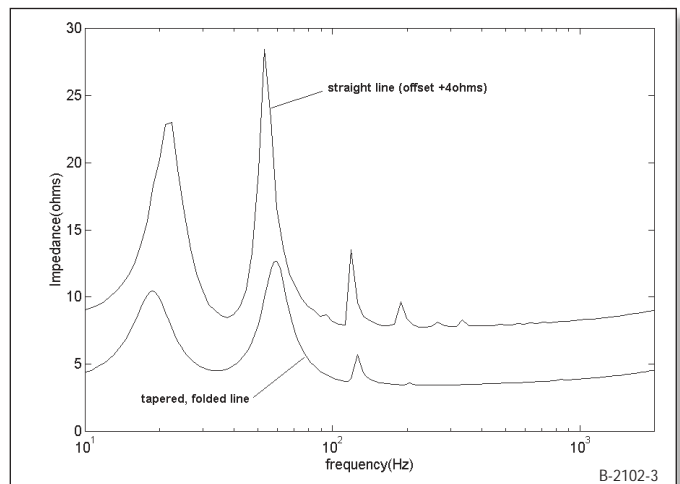

FIGURE 3: Unfilled transmission-line impedance comparison.

### Design speaker boxes with **BassBox Pro**

Design speaker boxes for any space: car, truck, van, home hi-fi, home theater, pro sound, studio, stage, PA and musical instruments. Import acoustic measurements. For example, the response of a car can be imported to simulate the in-car response.

**\$129**  
plus S&H

**Sophisticated Driver Modeling and Advanced Box Design**

- Multiple drivers with isobaric, push-pull and bessel options. • 3 dual voice coil wiring options. • "Expert Mode" dynamically analyzes driver parameters. • Design closed, vented, bandpass and passive radiator boxes. • "Suggest" feature provides fast box design. • All box types account for leakage losses and internal absorption.
- Advanced vent calculation. • Bandpass boxes can be single or double-tuned with 2 or 3 chambers. • 22 box shapes (shown below). • Open up to 10 designs at one time.
- Analyze small-signal performance with: Normalized Amplitude Response, Impedance, Phase and Group Delay graphs. • Analyze large-signal performance with: Custom Amplitude Response, Max Acoustic Power, Max Electric Input Power, Cone Displacement and Vent Air Velocity graphs. • Includes a helpful "Design Wizard" for beginners.

## Need help with your speaker designs? BassBox Pro & X-over Pro can help!

Harris Tech Pro software for Microsoft® Windows can help you quickly create professional speaker designs. Our software is easy to use with features like "Welcome" windows, context-sensitive "balloon" help, extensive online manuals with tutorials and beautifully illustrated printed manuals. We include the *world's largest driver database* with the parameters for many thousands of drivers.

For more information please visit our internet website at:  
[www.ht-audio.com](http://www.ht-audio.com)

Tel: 616-641-5924  
Fax: 616-641-5738  
sales@ht-audio.com

Harris Technologies, Inc.  
P.O. Box 622  
Edwardsburg, MI  
49112-0622  
U.S.A.

### Design crossovers with **X-over Pro**

Design 2-way and 3-way passive crossover networks, high-pass, band-pass or low-pass filters, impedance equalization, L-pads and series or parallel notch filters. Its Thiele-Small model provides professional results without complex testing.

**\$99**  
plus S&H

**Passive Crossover Filters and Scalable Driver Modeling**

- 1st, 2nd, 3rd and 4th-order "ladder" filter topologies. • Parallel crossover topology. • 2-way crossovers offer Bessel, Butterworth, Chebyshev, Gaussian, Legendre, Linear-Phase and Linkwitz-Riley filters. • 3-way crossovers offer All-Pass Crossover (APC) and Constant-Power Crossover (CPC) filters. X-over Pro's capabilities scale to fit the amount of driver data. • A crossover, filter or L-pad can be designed with just the nominal impedance of each driver. • With full Thiele-Small parameters, impedance equalization can be designed and the performance graphed.
- Graphs include: Normalized Amplitude Response, Impedance, Phase & Group Delay. • Graphs can include the full speaker response including the box. • Estimate component resistance (ESR & DCR). • Calculate the resistance of parallel or series components.

Copyright © 2002 by Harris Technologies, Inc. All rights reserved worldwide. BassBox is a trademark of Harris Tech. Other trademarks belong to their respective companies. Harris Tech reserves the right to make changes without notice. All prices are in U.S. dollars.

## LISTENING CRITIQUE

BY DENNIS COLIN

Here is a loudspeaker that appears to be without audible coloration; that's how it sounded to me. Now that's quite a statement, deserving of intense scrutiny. After all, Joe D'Appolito designed these speakers, so of course I thought they *should* be excellent.

Jiddu Krishnamurti, the (less than should be) famous observer of the human condition, taught that thought itself is a corruption of free observation. You must instantly forget all the past—beliefs, memory, attitude, and so on, as you do when surprised by something new—in order to freely and completely see the new, the present.

I have no trouble doing this when listening to (not analyzing) music I like. When reviewing an audio component, I listen; if I hear a sonic anomaly I focus on it, then call on the analysis tool called thought to attempt a description, e.g., “3dB dip at 2.5kHz,” “blown woofer,” and so forth. But then I shut this off and just listen again. After each piece of music, I write down my impressions.

You may still question whether I have a subconscious desire to believe a Joe D'Appolito-designed speaker must be good, or a simple desire to please a master. To this I mention that I've also designed speakers, including one I want to be the world's best. So my biases include a competitive factor that would incline me to go the extra mile to find fault with anyone else's speaker, including Joe's.

But I was able to disregard all biases—positive and negative—as I sat down and just listened.

### THE SOUND

Compared to any forward-only-facing speaker, I like the extra sense of ambience that a bipolar can provide, even if synthetically derived. To me, this can satisfactorily compensate the loss of original hall ambience in two- (and even 5.1) channel format limitations. This, however, I find true only in a highly damped room, such as my living room. In Joe's room, where I auditioned his speakers, there's more liveness (although very smooth), and I think a forward-only-facing speaker is the best. My impressions are:

1. Ambience. While desiring the presence of surround speakers (which Joe provided momentarily, resulting in astonishingly good 3-D ambience), this review is meant to be in pure two-channel stereo only. And as such, I heard an absolutely seamless, smooth, and deep stereo soundstage, even well off-axis. Not a hint of gaps, phasiness, or loss of tonal naturalness.

2. Tonal naturalness (“Presence” in the sonic ratings chart). I could simply hear no flaws, not even subtle colorations! The speakers are so acoustically transparent, though, that I had no trouble hearing many recording deficiencies, including those of the 16/44 CD medium. But mind you that free of the usual speaker anomalies, I thoroughly enjoyed the music.

One recording, even though a CD, is remarkably clean in detail and resolution: the Turtle Creek Chorale (I've mentioned its “goosebump factor” previously). On these speakers, I've *never heard more natural-sounding voice reproduction*, period. The performers sounded right there in front of me, yet the vocal fades into reverberation sounded infinitely far off. For a while I wanted to be a Tibetan monk so I could hear this all day!

3. Bass, midrange, treble, and balance. Sorry, nothing to comment on except personal perceptual flawlessness.

4. Bass. Now here's an area for comment: These are transmission-line (TL) speakers after all; TLs are supposed to have “different” bass. Before hearing these, I used to think “What's the big deal? TLs are just basically highly-damped open-back cabinets, aren't they?” Well, no!

First of all, the bass I heard was superbly damped; not a trace of “hangover” or emphasis. But the bass was also very deep and powerful. At one point, I was startled to hear a large bass drum impact shake me and the room down to at least 25Hz; as of this writing I

don't know the speakers'  $f_3$  or the bass room gain, but I do know I heard powerful and clean output to at least 25Hz, very surprising from a pair of 6½” woofers per channel.

Second, the bass *quality* was even more impressive. For example, with Jacintha singing “Georgia on My Mind,” the bass viol was the most natural and present sounding I've heard (not to mention Jacintha's voice and all else on the recording).

5. Transient Response and Image Clarity. A very good test is “Percussion Fantastic” (Fimco 017).

On these speakers, every detail of every percussion instrument was there with pristine immediacy and focus. With large tubular bells, for example, I clearly heard the subtle but lush midrange “knock” sound just before the blossoming resonance of the bell overtones, all spatially and temporally correct-sounding. From the deepest drums to what sounded like tiny (1”?) triangles (whose *fundamental* was probably 5kHz), the speakers never added any confusion.

6. Overall Impression. The speakers appear to reproduce whatever is fed them with flawless transparency. So well, they ruthlessly reveal any recording or medium deficiency. At one point, after criticizing some of Joe's recordings (which are much better than the average CD, mind you), I attempted to remove any sense of personal offense by saying “Joe, these speakers must be first-rate to reveal such fine details of recording imperfection!”

Now, how can you argue with that if you've designed the speakers? I felt like a politician making that statement, but nevertheless it's my true feeling.

7. One More Comment—To Sub or Not to Sub. Not! First, these speakers don't need any, unless you need response down to 5Hz. Second, I don't like separate sub (or any) woofers—I'm aware of a lack of coherence on well-recorded bass transients.

With these speakers, there was no audible separation or lack of coherence anywhere in the audio spectrum; the response in Joe's room sounded flat down to 25Hz. Of course, Joe *could* install eight 18” woofers (per channel) into the walls and design it to extend the response flat to 3Hz at 130dB SPL.

### OTHER SPECIFIC RECORDING IMPRESSIONS

*A Chorus Line*—Excellent including bass; opening percussion with great depth estimated to 25Hz (with possible room-gain contribution).

*Carmen*—Reproduced very clearly at peaks above 100dB SPL; speakers had no problem with the 200W/per channel amplifier probably driven near clipping.

*Beethoven “Pastoral”*—Tonality good, but recording seemed to have constricted ambience.

*Fanfare for the Common Man*—Very natural, deep, and spacious.

*Chopin/Rubenstein*—Hauntingly good music; piano recording technique sounded somewhat distant and dull. Not from speakers; other piano recordings could be first-rate.

*Tannoy Hi-Fi Sound Sampler*—One of the best recordings of string bass. Speakers delivered perfect-sounding tonality and space/time coherence. The overtone structure, instrument resonance, and sense of live string pulsiness sounded not just separately—good, but coherent live instruments.

*Dvorak Symph. #9, Solti*—Absolutely excellent in all regards.

*BSO, von Stade*—Very good instruments, voice somewhat overloaded in recording (present at any playback level, plus if it were the speakers, the instrument sound would have been intermodulated with the voice; it wasn't).

*Dvorak Piano Quartet*—No problem with *this* piano recording and reproduction thereof! One of the most analog-sounding (or more correctly, non-digital-sounding) CDs I've heard.

Up to this point, I hadn't seen any measurements. But now it's time to open the secret envelope.

(to page 16)

of a wavelength at  $f_{pT}$ .

$$L_{pT} = \frac{c}{f_p} = \frac{13584}{4 \times 58.2} = 58.4 \text{ in}$$

In this equation,  $c$ , the speed of sound in air, is taken to be 13584 in/sec. A similar calculation for the offset line gives a line frequency of 39.2Hz and a line length of 86.6". The total line

length actually used is 81". With this length an  $f_3$  of 44Hz is achieved.

Column 4 of Table 3 tells how to compute the TL internal volume as a function of  $V_{AS}$ . From Table 3 you find that:

$$\frac{V_{AS}}{V_p} = 0.9$$

Now  $V_{AS}$  for the MTM configuration is

twice the  $V_{AS}$  of a single driver or 74L. Solving for  $V_p$  you get:

$$V_p = \frac{V_{AS}}{0.9} = \frac{74}{0.9} = 82.2L = 2.905 \text{ ft}^3 = 5021 \text{ in}^3$$

You must establish at least two dimensions of the enclosure before you can use the volume calculation to get the final dimension. Here some practi-

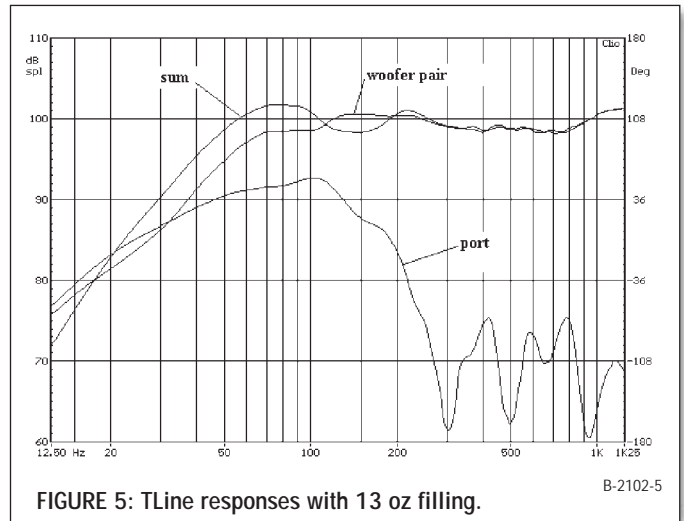
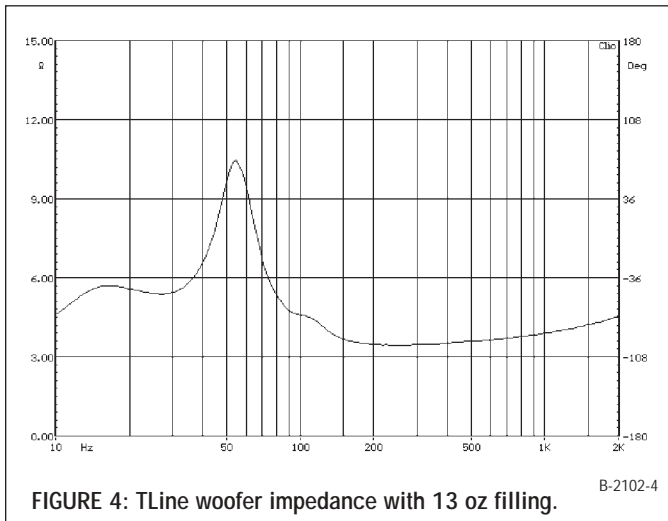



**General attenuator specifications**

Number of steps:	24	
Bandwidth (10kOhm):	50	MHz
THD:	0.0001	%
Attenuation accuracy:	±0.05	dB
Channel matching:	±0.05	dB
Mechanical life, min.	25,000	cycles

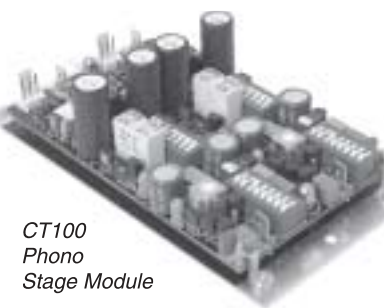

**CT100 key specifications**

Gain (selectable):	40 to 80	dB
RIAA eq. deviation:	± 0.05	dB
S/N ratio (40/80dB gain):	98/71	dB
THD:	0.0003	%
Output resistance:	0.1	ohm
Channel separation:	120	dB
Bandwidth:	2	MHz
PCB dimensions:	105 x 63	mm
	4.17 x 2.5	"

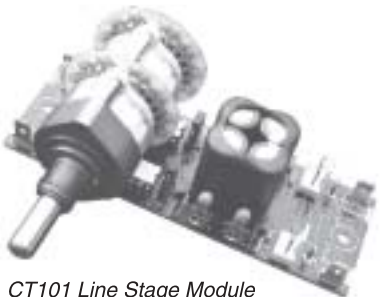

**CT101 key specifications**

Gain (selectable)	0, 6 or 12	dB
Bandwidth (at 0dB gain)	25	MHz
Slew rate (at 0dB gain)	500	V/uS
S/N ratio (IHF A)	112	dB
THD	0.0002	%
Output resistance	0.1	ohm
Channel matching	± 0.05	dB
PCB dimensions:	100 x 34	mm
	3.97 x 1.35	"

# DACT

DANISH AUDIO CONNECT

# DACT

Sales Dep.: Tel.: (+66) 2 260 6070  
Fax: (+66) 2 260 6071  
E-mail: info@DACT.com

<http://www.DACT.com>

**High quality audio parts** for upgrading existing equipment, DIY constructions and for audio equipment manufacturers. DACT audio components offer unusually large bandwidth, low distortion, high accuracy, low noise and long lifetime. DACT products:

- Stepped Audio Attenuators
- Stepped Balance Controls
- Audio Input Selector Switches
- Phono Stage Module
- Line Stage Module
- Different Accessories

Made in Denmark

cal considerations entered.

I knew I wanted a tweeter height of 34–35" to match ear height at my favorite listening position. I also knew from earlier experience with woofers of this size that a front baffle width should

be no greater than 9" for uniform horizontal polar response. Finally, I wanted to isolate the crossover from the main acoustic volume by placing it in the base of the enclosure.

These considerations led to a trial

layout for the front baffle of the THOR TL shown in *Fig. 1A*. Now all that was needed was to determine the interior and exterior depths of the line. A first cut at line depth went like this. Assuming 0.75" MDF for the sides and top leads to an internal width and height of 7.5" and 41.25", respectively.

The internal depth, *d*, is then computed as follows:

$$d = \frac{5021}{7.5 \times 41.25} = 16.25 \text{ in}$$

To get the external depth you must add the thickness of a 1" front baffle, a 0.75" internal baffle, and a 0.75" rear panel for an overall depth of 18.75". This number was considerably deeper than I wanted and would lead to a rather large and heavy enclosure.

PHOTO 2:  
Prototype crossover.

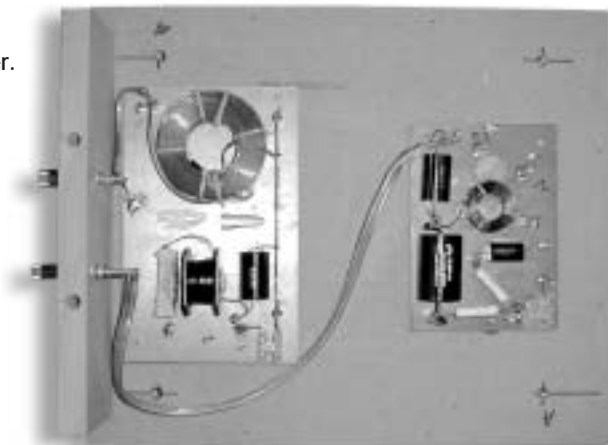

(from page 14)

### COMMENTS ON MEASUREMENTS

1. Joe has often said "Horizontal frequency response over a 60° arc is a good measure of perceived frequency response." Suffice it to say that *Fig. 16* agrees with my perception.

2. Regarding bass extension—*Figure 13* shows an LF -3 of 44Hz, with an ultimate LF slope of about 12dB/octave (similar to a closed, not vented box). As previously mentioned, I heard what I estimated to be strong 25Hz output. *Figure 13* is down about 12dB at 25Hz, so I would say room gain is helping here.

Since room gain (called "cabin gain" in a car) boosts LF output (re free air) at 12dB/octave, this can very well compensate a speaker's 12dB/octave rolloff. This is also true of closed-box systems, but the THOR TL had absolutely no "box-like" sound; bass was superbly natural.

### ABOUT ROOM GAIN

In free space, a small (re bass wavelengths) source must deliver constant air *acceleration* to radiate a constant sound *pressure* level versus frequency, because at lower and lower frequencies, less and less of a wavelength is "grabbed" by the source. Below *f<sub>3</sub>* of a closed-box speaker, however, the cone excursion (and air-volume *displacement*) is constant; acceleration (thus SPL) falls off at 12dB/octave. *Figure 13* shows THOR to do this also.

But in a confined space (room), below the frequency where the longest room dimension is about half wavelength, the air becomes pressurized as a whole. Thus, a constant speaker volume displacement produces air pressure cycles (SPL) of constant amplitude versus frequency; with no leakage (room and speaker), this would extend all the way to DC. So eight 18" woofers mounted in a wall *could* produce 130dB SPL at 3Hz—not recommended if you value your hearing (and walls)!

### RECORD REFERENCES

1. Chesnokov: "Spaseniye sodelal," Turtle Creek Chorale, Timothy Seelig, cond., Track 3, HDCD Sampler, Reference Recording RR-905CD.
2. Hamlich/Morita: "A Chorus Line," Turtle Creek Chorale/Dallas Women's Chorus, Timothy Seelig, cond., Track 4, HDCD Sampler, Reference Recording RR-905CD.

3. Jacintha, "Georgia on My Mind" from "Here's to Ben," First Impressions Music, FIM XRCD 020.
4. "Carmen Fantasy" from "Percussion Fantasia," Harold Faberman and the All Star Percussion Ensemble, First Impressions Music, FIMCD 017 (HDCD 24-bit recording).
5. Bizet-Shchedrin, "The Carmen Ballet," Orchestre Philharmonique de Monte Carlo, James DePriest, cond., Delos 3208.
6. Beethoven, Symphony No. 6, "The Pastoral," Hanover Band, Roy Goodman, cond., Nimus Records, N15099.
7. Chopin, "The Nocturnes," No. 2 in D-flat major, Artur Rubenstein, Piano, Musical Heritage Society 523870T.
8. Tannoy HiFi Series Sound Sampler, band 11, "Im Uomini, In Soldati," Mozart, Cecilia Bartoli, Wiener Kammerorchester, GyOrgy Fischer, cond.
9. Dvorak, Symphony No. 9, "From the New World," Chicago Symphony Orchestra, Sir George Solti, cond., London 410 116-2.
10. Berlioz, "Nuits d'ete," Frederica Von Stade, BSO, Seiji Ozawa, cond., CBS Master Works, MK 39098.
11. Dvorak, Piano Quartet in E-flat Major, OP. 87, 2<sup>nd</sup> movement, The Ames Quartet, Dorian-90125.

SONIC CHARACTERISTICS RATINGS		1	2	3	4	5	6	7	8	9	10
Presence	DC	█	█	█	█	█	█	█	█	█	█
Freedom From Distortion	DC	█	█	█	█	█	█	█	█	█	█
F.R. Smoothness	DC	█	█	█	█	█	█	█	█	█	█
L-M-H Balance	DC	█	█	█	█	█	█	█	█	█	█
Treble Quality	DC	█	█	█	█	█	█	█	█	█	█
Midrange Quality	DC	█	█	█	█	█	█	█	█	█	█
Bass Quality	DC	█	█	█	█	█	█	█	█	█	█
Bass Extension	DC	█	█	█	█	█	█	█	█	█	█
Immed. & Trans Response	DC	█	█	█	█	█	█	█	█	█	█
Image Focus	DC	█	█	█	█	█	█	█	█	█	█
Stereo Soundstage Realism	DC	█	█	█	█	█	█	█	█	█	█
Ambience	DC	█	█	█	█	█	█	█	█	█	█

At this point I made a number of arbitrary decisions. I chose a line taper of 3:1 and limited the overall depth to 13.5". This led to the internal layout of the line shown in Fig. 1A. Placing the interior baffle at an angle produces the desired taper. A side, but important, benefit of the interior baffle is that it adds greatly to enclosure rigidity, effectively clamping the side panels together and largely eliminating side-wall vibration.

The resulting layout has a throat area of 61.875 in<sup>2</sup>, which is roughly 1.6 times the combined diaphragm area of the two drivers, and an exit area of 20.625 in<sup>2</sup>. As you will see, this departure from Augspurger's recommendation has little effect on f<sub>3</sub>.

#### FILLING THE LINE

In Table 1, Part 3, of the Augspurger article<sup>4</sup>, the author recommends packing

densities for four filling materials. The optimum packing density is a function of line length. For my first trials I used polyester fiber ("Poly-Cat" polyfill available at Wal-Mart).

For a line length of 81" the recommended packing density is 0.78 lbs/ft<sup>3</sup>. To get the total amount of polyester needed you must calculate the TL internal volume. From Fig. 1A the internal volume is calculated to be

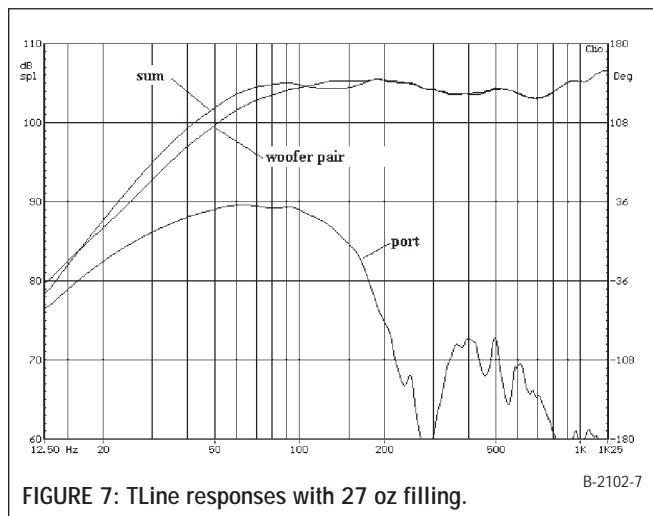
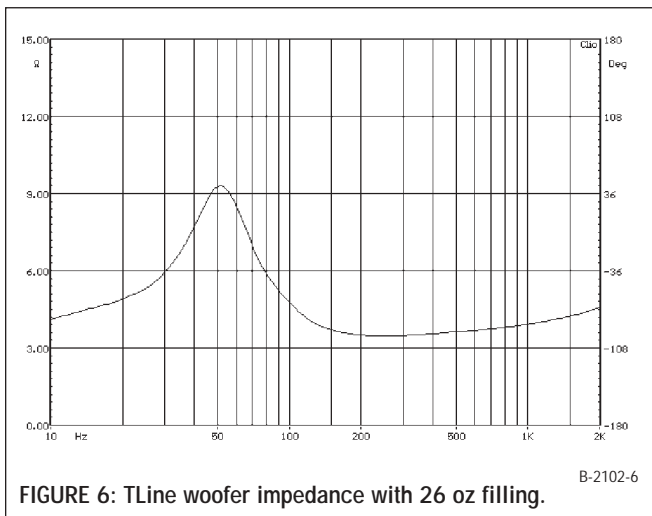

# SONIC CRAFT

Bringing Loudspeakers and the Hobbyist into the 21st Century

A Proud North American Distributor of

# ACCUTON

P.O. Box 9085, Wichita Falls, TX 76308, USA  
 Phone: (940) 689-9800; Fax: (940) 689-9618; E-mail: mail@soniccraft.com  
 See us at: www.soniccraft.com

1.934ft<sup>3</sup>, and the total amount of poly-fill needed is then  $1.934 \times 0.78 = 1.61 \text{ lbs} = 24.1 \text{ oz}$ .

In the past, some authors have suggested varying the packing density along the line length, but Augspurger found no particular advantage to this in his studies and recommended a uniform density. Getting a uniform packing density is a bit tricky, however, because the line volume per unit length is changing due to the taper.

Referring again to Fig. 1A, the volumes of the two line sections,  $V_1$  and  $V_2$ , are found to be 1.208ft<sup>3</sup> and 0.725ft<sup>3</sup>, respectively. These volumes represent 62.5% and 37.5% of the total line volume, respectively. Now to get a uniform packing density, you should place approximately 15 oz of the poly-fill in  $V_1$  and 9 oz in  $V_2$ .

### THE APPROACH TO LINE TRIMMING

Once TL dimensions are set, final trim-

ming of the TL packing density is done using a sequence of electrical impedance and acoustic measurements. I could jump to the final result, but I think the various steps in the process are instructive because they can be used in general to trim any transmission line. I will also take this opportunity to compare results from the tapered line with an equivalent straight line driven with a single woofer.

The acoustic measurements are similar to those used by Augspurger in his article. Near-field woofer and port SPL measurements are taken using the CLIO measurement system in the MLS

mode. The near-field technique is used to overcome the effects of low-frequency standing waves.

In this technique, the microphone is placed very close to the driver diaphragm (<0.1") to swamp out diffraction and room effects. At low frequencies where the diaphragm acts like a rigid piston, the measured near-field response is directly proportional to the far-field response and independent of the environment into which the driver radiates. Based on the diameter of the W18 woofers, the near-field woofer measurements are valid up to about 860Hz.

TABLE 4  
THOR SYSTEM SPECIFICATIONS

Frequency range(Hz)	40–25000	Sensitivity	89dB SPL
Short-term maximum power*	400W	Recommended amplifier	50–400W
Long-term maximum power*	200W	Dimensions(mm)	229 × 1060 × 343
Crossover frequency	2500Hz	Bass loading	Transmission line
Impedance	4Ω		
*IEC 268-5			

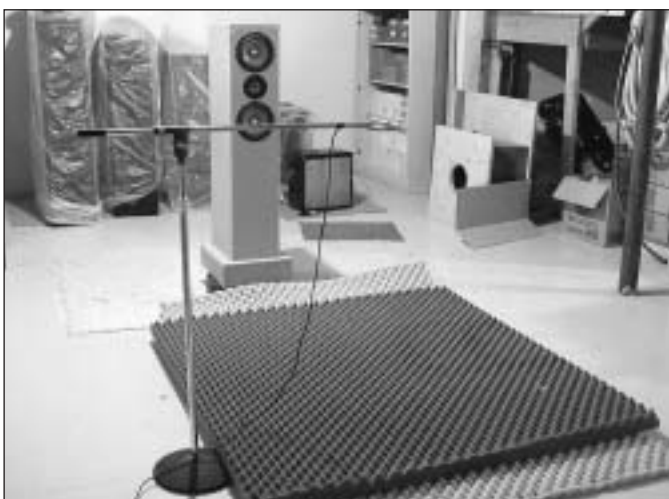
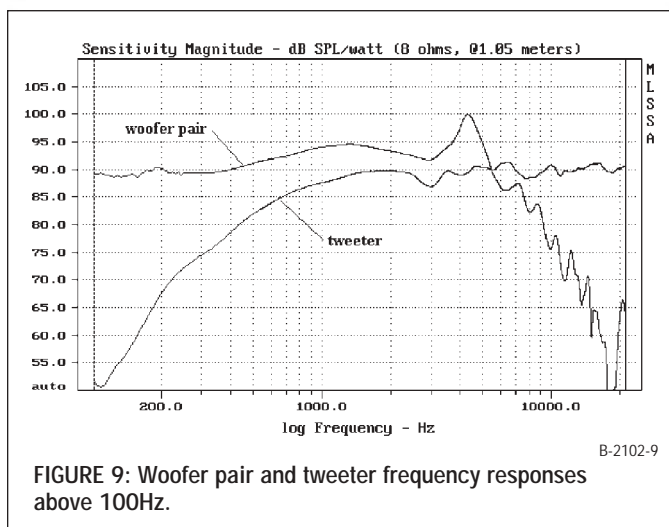
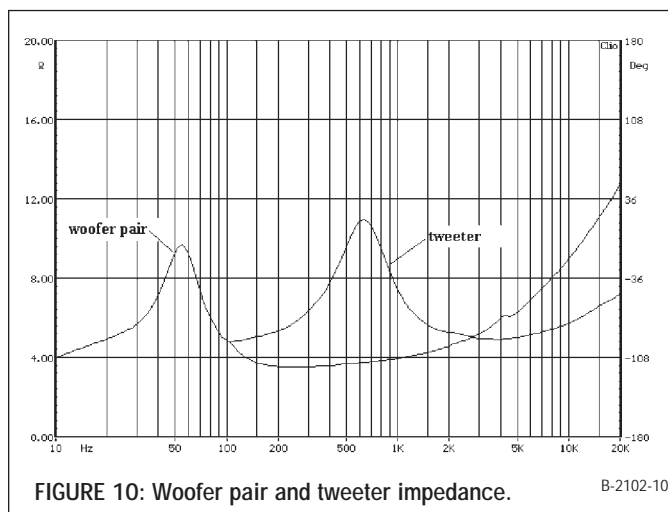
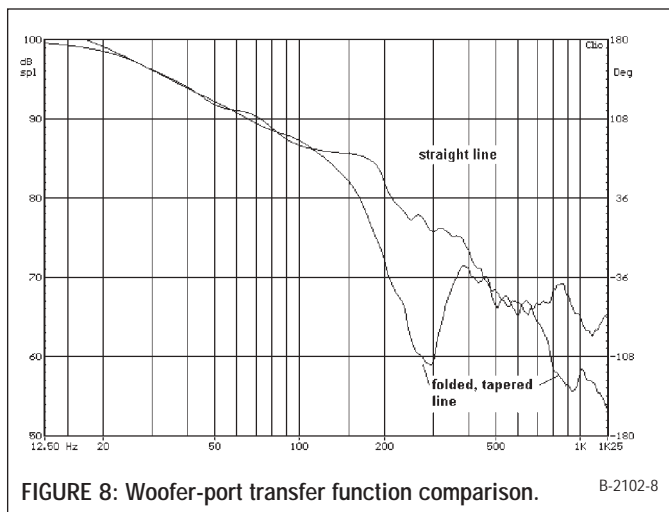

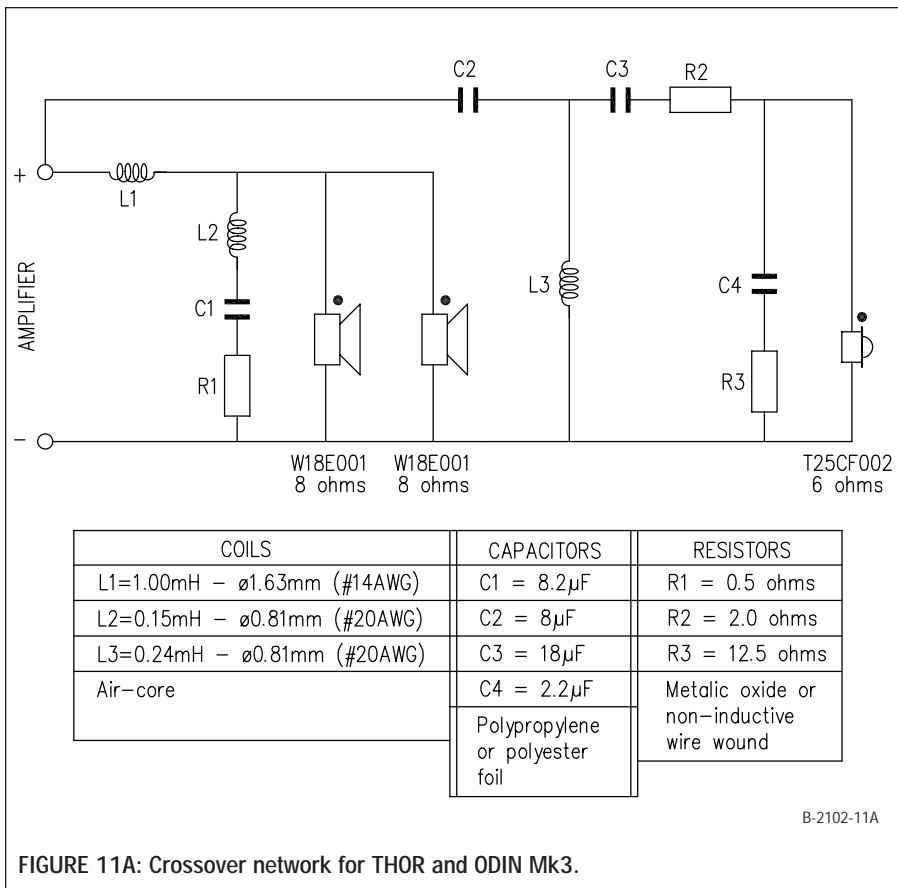

FIGURE 11A: Crossover network for THOR and ODIN Mk3.

CLIO works in the time domain and produces both amplitude and phase response data. The woofer and port responses are measured separately and then added, taking proper account of phase and woofer/port area differences to get the complete low-frequency response of the line. This process is described in detail in Chapters 4 and 7 of my book, *Testing Loudspeakers*<sup>5</sup>. Photo 1 shows the lab setup for testing and trimming the line.

When measuring the port near-field response, you must place the microphone in the plane of the port exit. The port measurement is then corrected by multiplying it by the square root of the ratio of port area to the combined area of the two woofers. This correction is:

$$\text{port response correction} = \sqrt{20.625/39.06} = 0.727$$

After correction, the port response is added to the two woofer responses to get the complete near-field TL response.

# The CLIO system

*Turns your PC into the most complete easy-to-use electrical and acoustical measurement system ...*

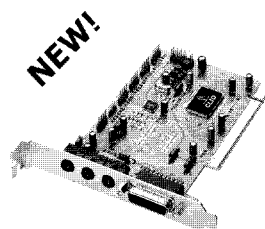

PB-4281 PCI PC Board + SC-01 Signal Conditioner

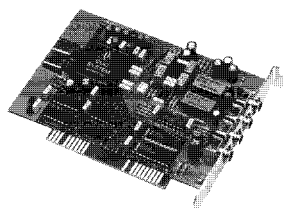
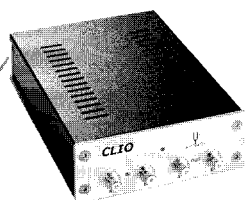

HR-2000 ISA PC Board

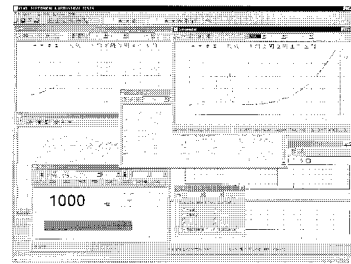

CLIOwin software rel.6.1

The **CLIO** system is a PC-based system for electrical and acoustical measurements. **CLIO** offers several measurement software, related measurement hardware and accessories. **A CLIO system is a complete test instrument**, 100% warranted by Audiomatica; all you need is to supply a compatible computer.

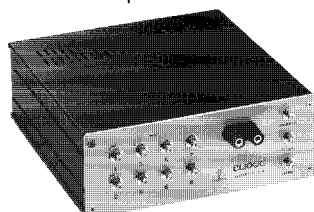

CLIOQC Amplifier&SwitchBox

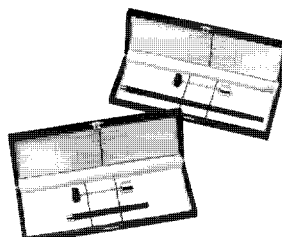

Microphones MIC-01 & MIC-02

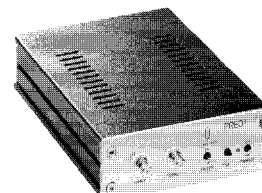

Preamplifier PRE-01



CLIO is produced by **AUDIOMATICA**

[www.cliowin.com](http://www.cliowin.com)  
[www.audiomatica.com](http://www.audiomatica.com)

There is a potential problem with near-field measurements of woofer response with the MTM configuration. If both woofers are driven simultaneously, the near-field response of one woofer

can be contaminated by the output from the second woofer because they are so close together. This is illustrated in *Fig. 2*.

The results shown in *Fig. 2* are for an

MTM speaker using two 5.25" woofers in a sealed enclosure, but the results will apply equally well to THOR. In this series of tests, the microphone is placed about 0.1" in front of the upper woofer dust cap.

*Figure 2* has three plots. One plot is the near-field data taken at the upper woofer with the lower woofer terminals shorted. A second plot shows the acoustic response measured at the upper woofer with the lower woofer driven and the upper woofer shorted. Below 60Hz, the lower woofer signal is only 10dB below the upper woofer output.

The third curve shows the response at the upper woofer with both woofers driven. You see that this plot is contaminated with some of the output from the lower woofer. In practice, the near-field response of each woofer is measured separately with the other woofer shorted, and then both responses are added to get the total low-frequency response of the woofer pair.

So far I've spoken only about acoustic

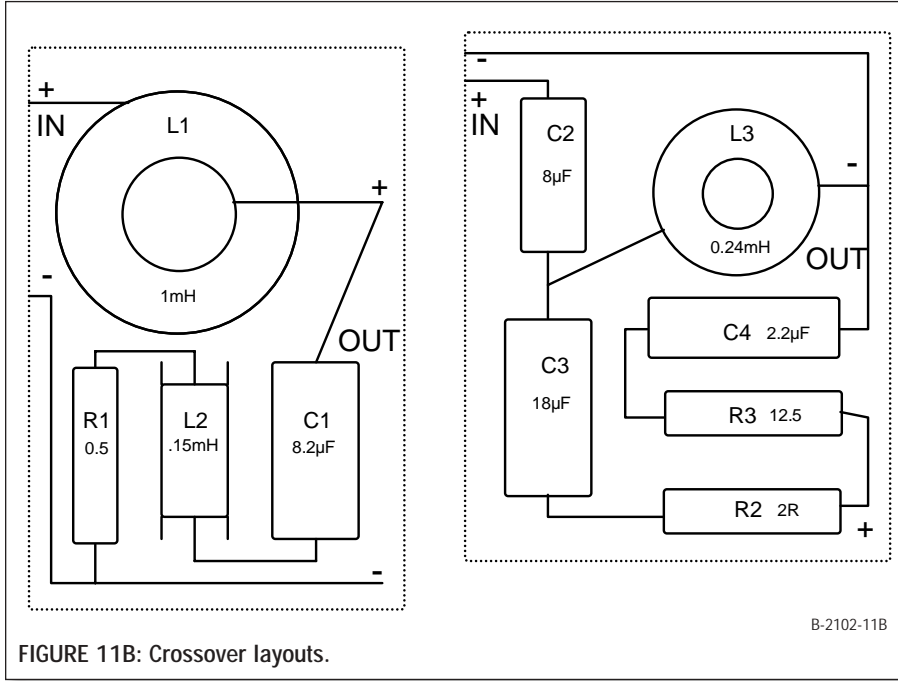

FIGURE 11B: Crossover layouts.

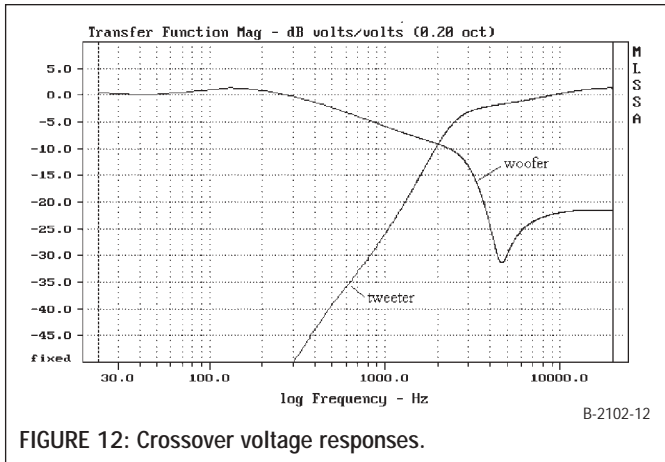

FIGURE 12: Crossover voltage responses.

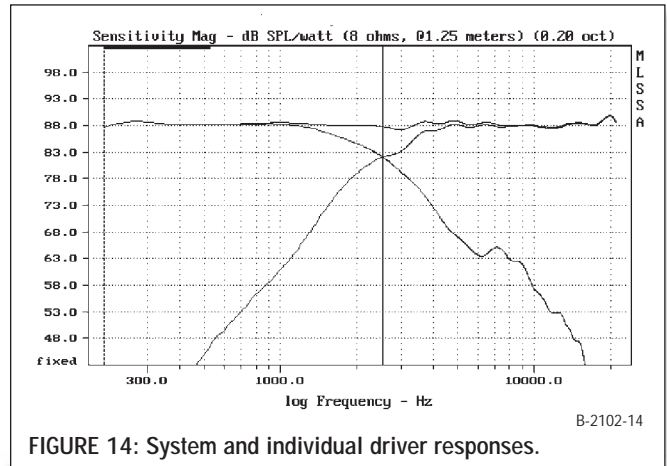

FIGURE 14: System and individual driver responses.

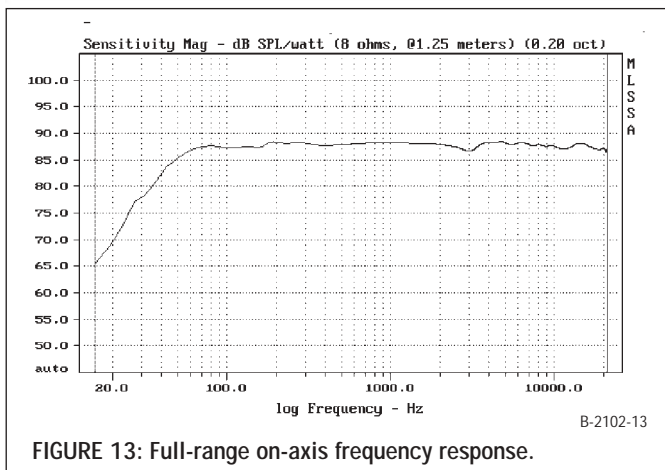

FIGURE 13: Full-range on-axis frequency response.

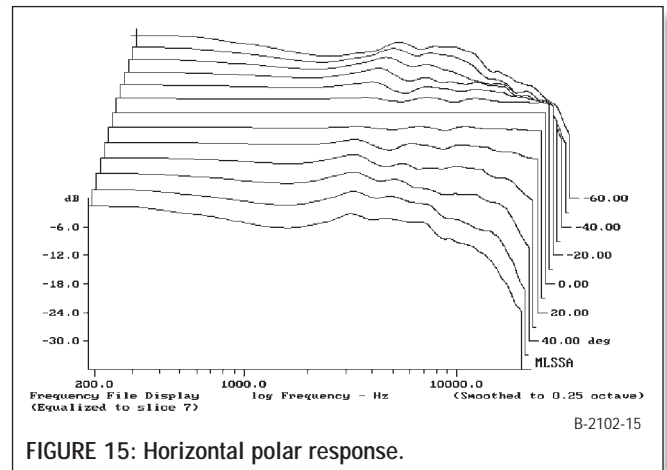

FIGURE 15: Horizontal polar response.

measurements, but you can also tell a great deal about TL performance from impedance data. *Figure 3* compares the measured woofer impedance of the tapered, folded line with an equivalent straight line. Both lines are unfilled. The straight-line plot is offset by  $+4\Omega$  to ease the comparison.

First notice that both lines exhibit the double-peaked curve of a vented loudspeaker. Thus, up to first order, the unfilled line acts much like a bass reflex speaker. However, you also see additional impedance peaks due to higher-order modes of the line. Beyond the first two peaks, the straight-line TL shows four additional peaks with increasing frequency.

Contrast this with the tapered, folded line where: 1) the minimum between the two lower peaks occurs at a lower frequency, 2) the curve about the minimum is broader and shallower, 3) all peaks are more highly damped relative to the straight line, and 4) only a total of three peaks are seen in the folded, tapered line versus six for the straight line.

These results support the contention that a tapered line has a lower fundamental resonant frequency and a broader range of support. The absence of higher-frequency peaks is due to folding the line. You will see this more clearly later on when you compare transfer functions for optimally damped straight and tapered lines in *Fig. 8*.

#### TRIMMING THE LINE

Rather than going directly to the "optimum" calculated packing density, I first packed the line uniformly to half the recommended density; i.e., 13 oz of polyfill. The impedance plot for this condition is shown in *Fig. 4*. Notice that the first impedance peak just below 20Hz is almost gone. The same is true for the third peak just above 100Hz. The impedance curve looks almost like that of a closed box speaker.

Responses of the woofer pair, the port, and their sum are shown in *Fig. 5*. The summed response shows a peak-to-peak ripple below 500Hz of  $\pm 1.7\text{dB}$ . The low-frequency  $f_3$  point relative to 500Hz is 41Hz. Below 41Hz response falls off at 12dB/octave.

Finally, observe that the port output augments woofer output by 4–5dB at all frequencies between 20Hz and 110Hz. From these results you can conclude that the lightly damped TL acts like an underdamped closed box system with 4–5dB increased low-frequency output capability.

The impedance curve of the optimally filled TL (24 oz) is shown in *Fig. 6*. Now all traces of line modes are gone and the curve is almost purely second-order like that of a closed box. The line is now essentially non-resonant. Responses of the woofer pair, the port, and their sum are shown in *Fig. 7*. The summed response ripple is  $\pm 0.6\text{dB}$  and  $f_3$  is 44Hz. Bass augmentation averages 3–4dB from 20Hz to 100Hz.

From these results you can conclude that for a fixed line length there is a trade-off between ripple response and  $f_3$  controlled by line damping. You also see that the line can be damped effectively by observing only the impedance curve. Damping should be adjusted until all traces of line modes just disappear from the impedance curve.

From the impedance plot you can compute an equivalent  $Q_{TC}$  for a second-order system with the same impedance curve using any of the procedures outlined in Chapter 2 of reference [5]. The value obtained is  $Q_{TC} = 0.55$ , indicating that the woofer pair is almost critically damped.

The woofer/port transfer function plot shows the acoustic output at the TL port produced by the acoustic input to the line coming off the rear of the woofer cones. If you compare the woofer/port transfer function for an optimally damped straight line against an optimally damped tapered and folded line, you get the plot shown in *Fig. 8*. Between 100 and 400Hz and again above 700Hz there is much less high-frequency acoustic output from the port of the folded, tapered line. This greatly reduces ripple in the 100 to 400Hz range relative to that of a straight line.

#### DESIGNING THE CROSSOVER

With the line optimally damped, my efforts now turned to the design of the crossover. Crossover design for me is a three-step process. First, I placed all

## seas THOR T-Line Speaker Kit

THOR is a new top-of-the-line loudspeaker kit developed by Dr. Joseph D'Appolito for SEAS. It is a full range, floor-standing system that provides the very highest level of acoustic performance.



Dimensions: 45½" H x 9" W x 14¼" D

This kit uses two Seas **Excel W18E001** magnesium woofers and **T25CF002 Millennium** Sonotex dome tweeter, mounted in a **D'Appolito** configuration. The enclosure uses a newly developed Transmission Line configuration, derived from sophisticated computer modeling and extensive experimentation. Usable in-room bass response extends to 30Hz.

Thor is an audiophile product sure to impress discriminating listeners. The **highs** are transparent. The **midrange** has exceptional clarity and openness. The **bass** is deep and solid.

The cabinets are assembled Oak veneer with solid Oak corners, in a Clear or Black finish. The grilles are black and are recessed flush with the speaker front. Assembly requires some skill at soldering.

Please visit our web site for more detailed information and upgrades.

**Price per pair: \$1585.00**

Madisound Speaker Components, Inc.  
P.O. Box 44283  
Madison, WI 53744-4283 USA  
Tel:608-831-3433 Fax:608-831-3771  
[madisound.com](http://madisound.com)  
[info@madisound.com](mailto:info@madisound.com)

drivers in the prototype enclosure of Fig. 1A and made acoustic and electrical measurements on them. The measurements include acoustic frequency and phase response, acoustic phase center and electrical impedance. This process is described in detail in Chapter 7 of reference [5].

I then enter this data into one of the many crossover optimization programs I have to develop a preliminary crossover design. Lest you think that this process is automatic and that the software does all the work, be warned that these optimization programs are quite dumb. They cannot decide on an optimum crossover topology and they do not know which components should be optimized and which should be left alone. This is where the “art” of crossover design with optimization software comes in. The software saves many hours of experimentation, producing a preliminary design that gets you quickly into the ballpark, but the designer must pick the right crossover topology and guide the optimization

process to a reasonable result.

In the last step I built the preliminary crossover and auditioned it extensively, and used these listening tests for the final tailoring of loudspeaker performance.

### CROSSOVER DESIGN CRITERIA

In designing a crossover I have two primary requirements: 1) flat on-axis first arrival response and 2) uniform horizontal polar response. Directional cues so important to imaging are determined primarily by a loudspeaker’s first arrival response, which should be relatively flat to avoid amplitude distortion of the directional information.

However, the overall frequency balance of a loudspeaker as perceived by a human listener is a combination of direct and reflected sound. Off-axis energy arrives at the listening position after reflection off the walls. In typical listening rooms this energy arrives well within the Haas fusion zone, a time interval starting just after the first arrival and extending out to

40–50ms. Even if the on-axis response is flat, poor off-axis response can produce a perceived colored frequency balance.

For good stereo imaging and proper spectral balance from side-wall reflections, the horizontal polar response off-axis curves should be smooth replicas of the on-axis response with an allowable exception for the natural rolloff of the tweeter at higher frequencies and larger off-axis angles. (Our ear-brain combination tends to reject higher-frequency side-wall reflections.)

There are several other important quantitative measures of speaker performance, but these are not controlled directly by the crossover network. See my many loudspeaker test reviews in *audioXpress* for a complete discussion of these other measures.

### INDIVIDUAL DRIVER TESTING

Figure 9 shows the quasi-anechoic frequency response (first arrival response) of the woofer pair and tweeter with the microphone placed on the tweeter axis

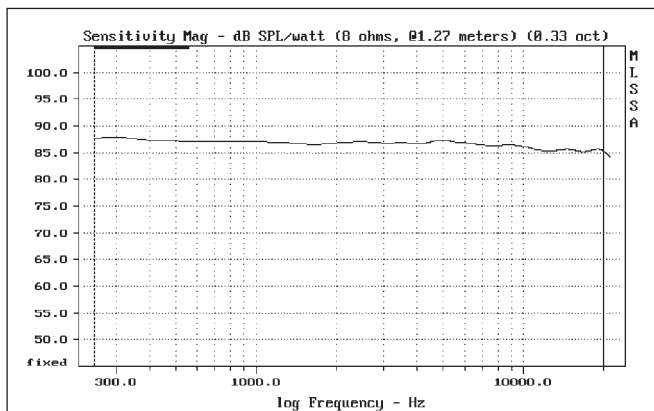

FIGURE 16: THOR average horizontal response over  $\pm 30^\circ$ .

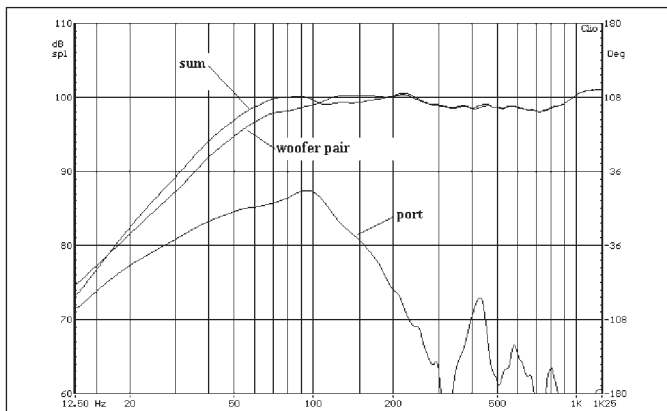

FIGURE 18: TLine responses: 13 oz front and 7 oz batting.

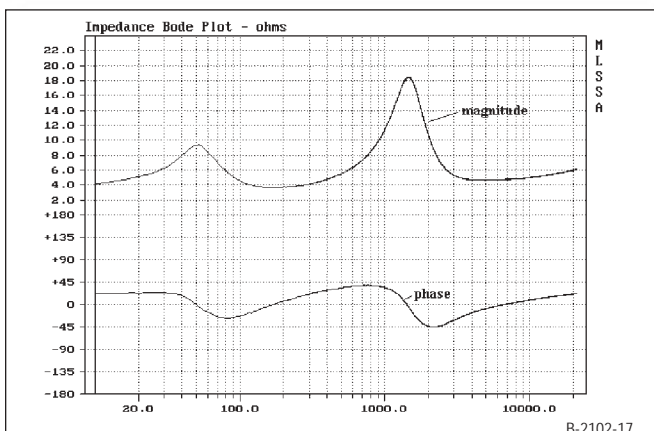

FIGURE 17: THOR impedance magnitude and phase.



PHOTO 4: Parts kit from Madisound.

at a distance of 1.25m. The plot scale covers 100Hz to 20kHz. The data is then normalized to 1m to get driver sensitivity. (Woofer pair response below 100Hz is determined via near-field techniques previously discussed.)

Tweeter response averages 90dB SPL/1m/2.83V above 2kHz. Below 2kHz tweeter response falls off smoothly with a slightly over-damped response.

Starting at about 1500Hz the woofer pair response falls 5dB with decreasing frequency, reaching a uniform level of about 90dB at and below 400Hz. The fall-off is due to the spreading loss characteristic of all woofers on narrow baffles ([5], Chapter 4). The woofer peaks to 100dB at 4.4kHz and then falls off at an average rate of 24dB/octave one octave above that frequency.

Frequency responses of the woofer pair and tweeter overlap between 1.2kHz and 5kHz, suggesting that a preliminary value of 2.5kHz for the crossover frequency would be a good place to start design. This frequency may be subject to change depending upon the resulting horizontal polar response.

Woofer pair and tweeter impedances are plotted in Fig. 10. The woofer pair impedance of Fig. 7 has been extended out to 20kHz.

#### CROSSOVER TOPOLOGY SELECTION AND OPTIMIZATION

I favor in-phase, i.e., even-order, crossovers for most applications be-

cause they are the least sensitive to inter-driver phase differences and timing errors. In the case of the MTM configuration they also limit off-axis response in the vertical which greatly reduces floor and ceiling reflections. For the THOR TL the goal was to design a fourth-order acoustic crossover re-

sponse at a crossover frequency of 2500Hz.

The woofer crossover must accomplish three functions: 1) control the response rise between 400Hz and 1.5kHz, 2) suppress the 100dB woofer peak at 4.4kHz, and 3) provide the final high-frequency rolloff, which, when com-

### Precision Acoustic Measurements Require Precision Microphones



PS9200KIT™ \$1650 USD

A complete IEC and ANSI traceable Type 1 Measurement Microphone System 2 Hz to 40 kHz, 15 dBA to 160 dB SPL

\*1/2 inch capsule \*4012 Preamp \*PS9200 2 Channel PS

\*AC adaptor \*WS1 windscreen \*SC1 die cut storage case.

Options: 511E Calibrator; 1 & 1/4 inch mics; and Gain for

DRA's MLSSA and other board level products.

#### ACO Pacific, Inc.

2604 Read Ave. Belmont, CA 94002 USA

Tel: (650) 595-8588 FAX: (650) 591-2891

e-mail acopac@acopacific.com

ACOustics Begins With ACO™



### INTRODUCING THE NEXT GENERATION OF PLANAR TRANSDUCERS

PL-160 the first planar driver with esoteric-Binary Interlaced Coil- **BIC** diaphragm field exchangeable. A distinct performance driver with electroacoustic virtues, satisfying critical listeners and functionality motivating ambitious designers. All in a single, state of the art device.

#### FEATURES - PERFORMANCE - SPECIFICATIONS

- Ultrafast transient response, for stunning transparency
- Linear Phase response, for time coherent reproduction results in accurate imaging and sonic clarity
- True line source image behavior
- Controlled dispersion in horizontal and vertical plane
- Frequency response 1.6-40KHz
- Sensitivity 2.83vrms/1M 97db SPL
- Extremely light, ultrathin, Hi temperature, Interchangeable diaphragms in Ohmic Values: 2 x 9 - 2 x 5,3 - 2 x 3,4\*
- Constant resistive impedance throughout operating range for ideal amplifier load and easy crossover design
- Massive, Neodymium, High energy magnet system
- Magnetically shielded system
- Baffle mounting without screws
- Rear support for free standing upgrading applications
- Dimensions: W x H x D mm: 84 x 164 x 100 Weight 1,5kg

#### THE NEW **BIC** DESIGN IDEAS THAT HELP YOU BUILT BETTER SPEAKERS

Double coil proprietary diaphragm configuration allows series connection for max transducer sensitivity or parallel connection for max power handling.

The two symmetrical interlaced coils, break the rules of acoustic reproduction in many fronts such as:

- Crossover at two different frequencies
- Feedback optimizer circuitry
- Magnetic damping circuitry
- DDL (Direct Digital Loudspeaker) circuitry
- Possible other inventive applications

Unit price: \$ 320 (includes delivery to your address)

\*PL-160 is sold with 2 x 9 Ohms diaphragm.

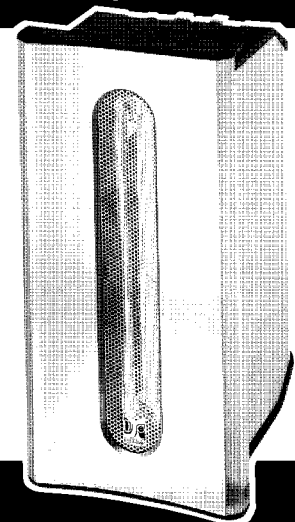

For orders visit our web page [www.dynasonic.gr](http://www.dynasonic.gr) E-mail: [info@dynasonic.gr](mailto:info@dynasonic.gr)

Or contact us directly at:

DYNASONIC LTD 59, tritis Septemvriou str., Athens 104 33, Greece, tel.: +30-1-88 30 311, fax: +30-1-82 29 483

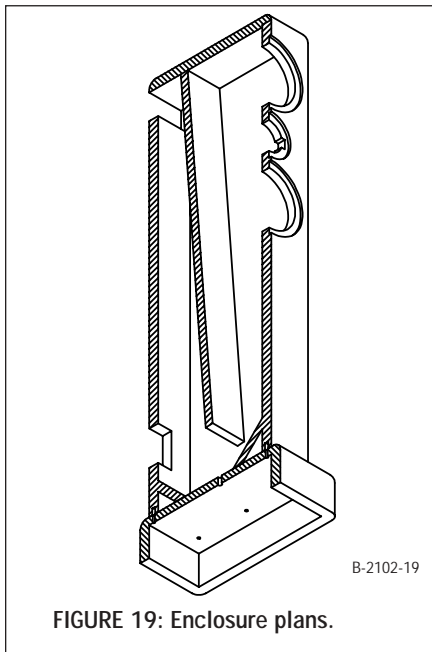

FIGURE 19: Enclosure plans.



PHOTO 5: An enclosure version from Madisound.

combined with the woofer's natural response, produces the desired 24dB/octave acoustic decay.

To adequately protect the tweeter the electrical rolloff of the tweeter crossover must be at least 12dB/octave at all frequencies below crossover. The tweeter's acoustic rolloff below 1kHz begins at a rate of 6dB/octave and transitions to 12dB/octave below 300Hz. The tweeter crossover must therefore produce an electrical attenuation starting at 18dB/octave and then transition 12dB/octave to attain the desired overall 24dB/octave acoustic rolloff.

With these points in mind the crossover circuit topologies I finally

selected are shown in *Fig. 11*. Look at the woofer pair crossover first. There is a tendency in crossover design to separate the basic crossover action from the specialized functions of spreading loss correction and response peak suppression.

There is also an often-unthinking use of Zobel impedance compensation when better performance is often obtained without one. This leads to overly complex crossovers. The woofer crossover topology I finally settled on combines the three required functions with an economy of parts and results in absolutely astounding and seamless driver integration.

Woofer and tweeter crossover voltage transfer functions after optimization are shown in *Fig. 12*. For those of you with some circuit theory background, the woofer crossover is a third-order electrical filter with a second-order zero. The woofer crossover voltage response is explained as follows.

L1 provides an initial rolloff of 6dB/octave starting at 400Hz to compensate for rising response of the woofer pair. The R1, C1, L2 triple forms a series-resonant shunt that comes into play around 2500Hz. It produces a 31dB notch at the woofer peak and provides additional high-frequency rolloff. Resistor R1 controls the depth of the notch. Finally, beyond 10kHz the woofer crossover response flattens out, but that is OK because the woofers are falling off at 24dB/octave above the notch.

With a Zobel, the woofer crossover response would continue to fall off above 10kHz at a 6dB/octave rate. Without a Zobel, however, the rising impedance of L1 is matched by the rising impedance of the woofer pair voice coils, resulting in no net electrical rolloff.

*Figure 12* also shows the 18dB/octave rolloff required by the tweeter below 1kHz. The tweeter crossover output is down 36dB at 600Hz, the tweeter's measured resonant frequency. The transition to 12dB/octave occurs below the scale of the plot.

Crossover parts values are also listed in *Fig. 11A*. It is very important to use the specified coil wire size for L3. Below 300Hz L3 coil resistance dominates over coil inductive reactance so that the crossover looks like a double RC fil-

ter giving the required 12dB/octave attenuation. A larger wire size would reduce coil resistance and push the transition frequency down to a lower value. Resist the urge to use a larger wire size. *Photo 2* shows the prototype crossover.

## FREQUENCY AND POLAR RESPONSE TEST RESULTS

*Photo 3* shows the prototype TL ready for testing in my lab. *Figure 13* shows the full-range quasi-anechoic frequency response obtained with the microphone placed on the tweeter axis at a distance of 1.25m. Response is flat within  $\pm 1$ dB from 200Hz to 20kHz. Low-frequency  $f_3$  is 44Hz. Sensitivity averages 88dB SPL/1m/2.83V.

*Figure 14* shows system frequency response and response of the individual drivers on an expanded frequency scale. On this plot the crossover frequency is highlighted at 2526Hz, satisfyingly close to the target crossover of 2500Hz.

Horizontal polar response is examined in *Figs. 15* and *16*. *Figure 15* is a waterfall plot of horizontal polar response in 10° increments from 60° right (-60°) to 60° left (+60°) when facing the speaker. All off-axis plots are referenced to the on-axis response, which appears as a straight line at 0.00°. Thus, the plotted curves show the change in response as you move off-axis.

For good stereo imaging the off-axis curves should be smooth replicas of the on-axis response with the possible exception of some tweeter rolloff at higher frequencies and larger off-axis angles. For home theater applications a more restricted high-frequency response may be desirable.

From *Fig. 15* you find that the -3dB beam width at crossover is  $\pm 50^\circ$ . There is a bit more off-axis droop around 1500Hz, but the -3dB beam width is still  $\pm 45^\circ$ . Above 15kHz and at angles greater than 40° there is a fairly steep fall-off in response that is characteristic of 28mm tweeters with a recessed dome. But, as I indicated earlier, this performance is perfectly acceptable. The -3dB beam width at 15kHz is still  $\pm 25^\circ$ .

The average horizontal frequency response over a 60° arc is a good measure of perceived frequency response. This average response is plotted in *Fig. 16*. Relative to 1kHz, response at 10kHz is

down only 0.9dB. At 20kHz the figure is 1.4dB. This plot, in particular, shows THOR's excellent in-room frequency balance.

THOR's impedance magnitude and phase are plotted in *Fig. 17*. The minimum impedance of  $3.6\Omega$  occurs at 180Hz. The impedance peak of  $18.3\Omega$  at 1.5kHz is caused by the interaction of the woofer and tweeter crossover networks forming a parallel resonance at that frequency. The maximum phase angle of  $45^\circ$  occurs at 2140Hz, but the impedance magnitude at that

point is  $10\Omega$ . The system impedance is rated at  $4\Omega$ .

### PRACTICAL CONSIDERATIONS

After many months of operation, the Dacron pillow filler settled in the second half (the rising part) of one of the lines. This occurs only in the second half of the line because it expands toward the bottom of the enclosure giving little support to the filling material. The settling did not appear to affect performance, but the problem can be avoided altogether by using either Acousta Stuf (available from Mahogany Sound) or Dacron Quilt padding in the second half of the line. Performance will be the same with either solution.

In the case of Acousta Stuf you will need 21 oz of material divided into 13 oz for the first half and 8 oz for the second half of the line. This material must be thoroughly teased out to fill each volume.

Alternatively, you can fill the second half of the line with

Dacron Quilt padding, which will retain its shape when placed in the line. You will need about 9 oz of the material. Cut it into three 7.5" wide strips.

The first strip should equal the length of the last half of the line. The second and third strips should be two-thirds and one-third the length of the first, respectively. The longest strip fills the second half of the line, while the second and third strips fill two-thirds and one-third of the lower portions of the line, respectively. Low-frequency response using the quilt padding is shown in *Fig. 18*.

### CONSTRUCTION

I will not give detailed instructions for building the THOR enclosure. Enclosure plans are given at the end of this article (*Fig. 19*) and also are available on the SEAS website at [www.seas.no](http://www.seas.no). We have provided a cutting guide (*Fig. 20*) that also specifies the total amount of material needed for each enclosure. Any experienced woodworker should be able to follow the plans without difficulty.

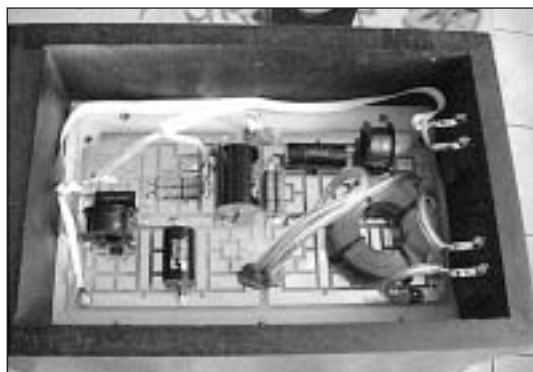

PHOTO 6: Madisound's finished crossover.

#### COMPONENTS:

SOLEN HEPTA-LITZ AND STANDARD INDUCTORS AND CAPACITORS - THE CHOICE OF MANY HIGH-END SPEAKER MANUFACTURERS.

#### HARDWARE:

POWER RESISTORS, L-PADS, CABLE, ABSORBING AND DAMPING MATERIALS, GOLD SPEAKER TERMINALS, GOLD BANANA PLUGS AND BINDING POSTS, GRILL FASTENERS, PORT TUBES AND TRIM RINGS, PAN HEAD SCREWS, SPIKES AND TEE NUTS WITH ALLEN HEAD BOLTS AND PLENTY MORE...



## Solen crossover components - used by the most discriminating loudspeaker manufacturers.



#### SOLEN HEPTA-LITZ INDUCTORS

Air Cored Inductors, Litz-Wire Perfect Lay Hexagonal Winding  
Values from .10 mH to 30 mH  
Wire Size from 1.3 mm (16AWG) to 2.6 mm (10 AWG) 7 Strands

#### SOLEN STANDARD INDUCTORS

Air Cored Inductors, Solid Wire Perfect Lay Hexagonal Winding  
Values from .10 mH to 30mH  
Wire Size from 0.8 mm (20AWG) to 2.6 mm (10 AWG)



#### SOLEN FAST CAPACITORS

Fast Capacitors, Metalized Polypropylene  
Values from 0.10  $\mu\text{F}$  to 330  $\mu\text{F}$   
Voltage Rating: 630, 400, 250 VDC

#### CROSSOVER AND SPEAKER PARTS

Metalized Polyester Capacitors, 1.0  $\mu\text{F}$  to 47  $\mu\text{F}$ , 160 VDC, Non Polar Electrolytic Capacitor, 22  $\mu\text{F}$  to 330  $\mu\text{F}$ , 100 VDC, Power Resistors 10 W, 1.0  $\Omega$  to 82  $\Omega$ , 8  $\Omega$  L-Pads plus all the hardware and supplies to complete any speaker project.

CALL TO ORDER THE SOLEN CROSSOVER COMPONENT CATALOG FOR \$8.00 PACKAGED WITH THE COMPREHENSIVE SOLEN SPEAKER DRIVER COMPONENTS CATALOG.



### SOLEN INC.

4470 Avenue Thibault  
St-Hubert, QC J3Y 7T9  
Canada

Tel: 450.656.2759

Fax: 450.443.4949

Email: [solen@solen.ca](mailto:solen@solen.ca)

WEB: <http://www.solen.ca>

For those of you who do not care to build the cabinets from scratch, enclosures are available from the sources listed at the end of the article. A complete kit of parts including drivers and crossovers is also available from these sources. *Photo 4* shows the parts kit provided by Madisound. One version of the enclosure also available from Madisound is shown in *Photo 5*, filled and ready for driver installation. *Photo 6* shows a finished crossover mounted in the base of the enclosure.

### SUMMARY

In this article you have seen that

Augspurger's work represents an excellent starting point for the design of transmission-line loudspeakers. His recommendations on packing density versus line length are right on target. Once a prototype line is built, the optimum packing density is easily determined experimentally with a sequence of acoustic and/or electrical impedance measurements. Similar acoustic and impedance measurements on the drivers mounted in the prototype enclosure then provide the data for rapid CAD design of a trial crossover network. ❖

### REFERENCES

1. G. L. Augspurger, "Loudspeakers in Damped Pipes—Part One: Modeling and Testing; and Part Two: Behavior," 107th JAES Convention, 24–27 September, 1999, Preprint No. 5011.
2. G. L. Augspurger, "Transmission Lines Updated, Part 1," SB 2/00.
3. G. L. Augspurger, "Transmission Lines Updated, Part 2," SB 3/00.
4. G. L. Augspurger, "Transmission Lines Updated, Part 3," SB 4/00.
5. J. A. D'Appolito, *Testing Loudspeakers*, Audio Amateur Corporation, Peterborough, NH, 1998.

### SOURCES FOR THOR KIT PARTS

Zalytron Industries: [www.zalytron.com](http://www.zalytron.com)  
 Madisound: [www.madisound.com](http://www.madisound.com)

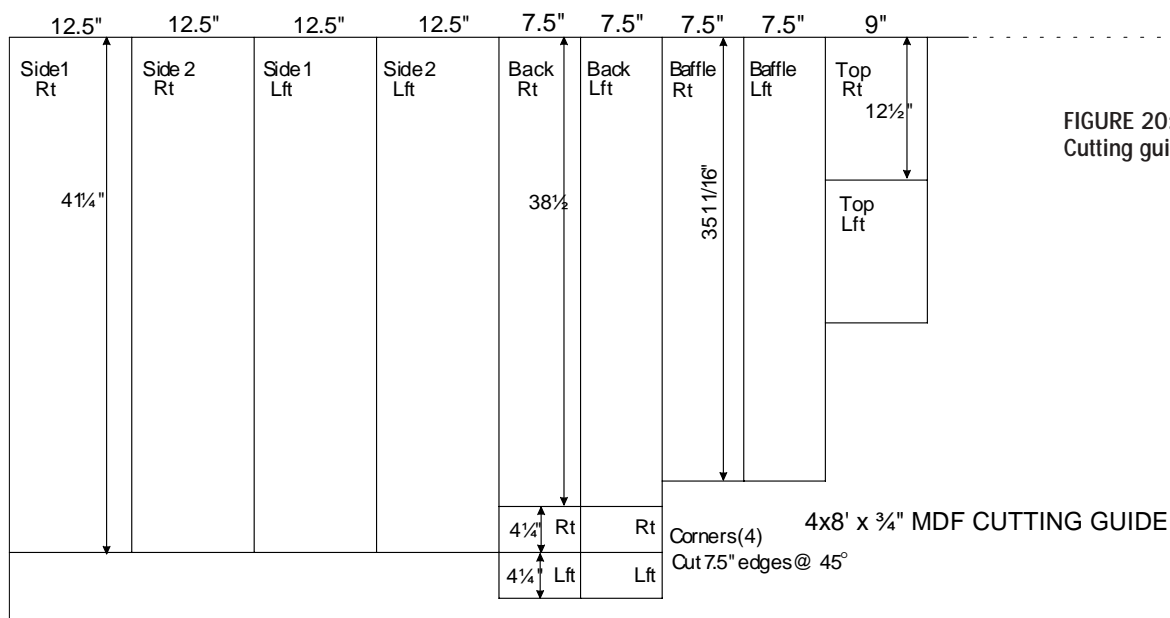
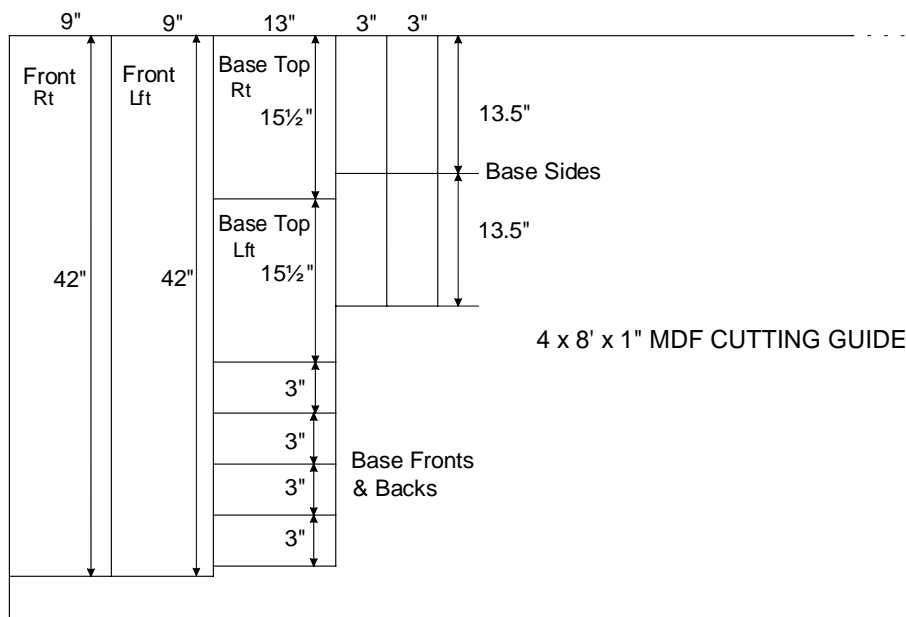

FIGURE 20: Cutting guide.



NOT TO SCALE

B-2102-20

## THOR CUTTING GUIDE

If you can find remnants of 1" stock for the front panels without having to purchase a full sheet, then the parts for the base may easily be adapted to be cut from the stock remaining in the 3/4" sheet of MDF. Maintain the same outer dimensions for the base.

If you must buy a full sheet of 1" MDF, the lumberyard will probably do straight cuts for dividing the heavy panel to get it delivered more easily. I had mine cut at 39" to transport it. If your lumberyard attendant is really helpful, two cuts at 9" and one at 13" will do most of your work for you.

If you must cut your own pieces, set the saw width to 9" for the front panels, then to 13" for the top of the base and the front and back panels of the base. Reset for 3" to cut off the base fronts and

backs. The base sides can be cut with the 3" setting, then the four base fronts and backs cut from the end of the 13" cut. Since the crossover boards fit easily into the base, input connectors are best located on the rear of the base. Rout out an appropriate amount of the rear wall to thickness which will accommodate your choice of connector hardware.

The cutting guide for the 3/4" sheet is also not very economical. If your lumberyard cuts a 51" piece from one end, you'll probably be able to get the two pieces into your car. Set your saw for 12 1/2" for the four sides, then to 7 1/2" for the backs and the T-line baffles. A 9" setting will provide the width for the tops.

The four corner pieces, which make up the "turns" for the corners of the line, should have their long edges cut at 45° angles, 4 1/4" wide. Carefully trim one end of the baffle at an angle of 86°.

### PARTS IDENTIFICATION

#### ONE-INCH-THICK MDF

NO. PCS	SIZE (IN.)	PART
<b>T Line Cabinet</b>		
2	42 × 9	Front
<b>Base</b>		
2	5 1/2 × 13	Top
4	13 × 3	End
4	13 1/2 × 3	Side

#### THREE-QUARTER-INCH-THICK MDF

NO. PCS	SIZE (IN.)	PART
<b>T Line Cabinet</b>		
4	41 1/4 × 12 1/2	Side
2	38 1/2 × 7 1/2	Back
2	35 1/16 × 7	Baffle
2	12 1/2 × 9	Top
4	7 1/2 × 4 1/4	Corners (Bevel 7 1/2 side @ 45°)

#### PLEASE NOTE:

SEAS Fabrikker AS of Moss, Norway, has published a very early version of the THOR cabinet drawing based on a preliminary sketch provided by author D'Appolito which has been on several websites for many months. The drawing differs in a variety of dimensions based on 1" MDF for the walls, top, and back panels. A new drawing is available on their web site <http://www.seas.no/thor.html> conforming to walls of 3/4" material. The diagrams, cutting guides, and all dimensions published in *audioXpress* conform exactly to the D'Appolito prototype, with the exception of the base where the prototype is made of 3/4" MDF.—**E.T.D.**

# LANGREX SUPPLIES LTD

DISTRIBUTORS OF ELECTRONIC VALVES, TUBES & SEMICONDUCTORS AND I.C.S.

1 MAYO ROAD, CROYDON, SURREY, ENGLAND CR0 2QP

24 HOUR EXPRESS MAIL ORDER SERVICE ON STOCK ITEMS

PHONE

44-208-684-1166

E-MAIL: LANGREX@AOL.COM

FAX

44-208-684-3056

## A SELECTION OF OUR STOCKS OF NEW ORIGINAL VALVES/TUBES MANY OTHER BRANDS AVAILABLE

STANDARD TYPES			AMERICAN TYPES			SPECIAL QUALITY TYPES		
ECC81	RFT	3.00	5R4GY	RCA	7.50	A2900/CV6091	G.E.C.	17.50
ECC82	RFT	6.00	5U4GB	SYLVANIA	10.00	E82CC	SIEMENS	7.50
ECC83	RFT	8.00	5Y3WGT	SYLVANIA	5.00	E83CC	TESLA	7.50
ECC83	EI	3.00	6BX7GT	GE	7.50	E88CC G. PIN	TESLA	8.50
ECC85	RFT	5.00	6FQ7	SYLVANIA	7.50	E188CC	MULLARD	20.00
ECC88	BRIMAR	6.00	6L6GC	SYLVANIA	20.00	ECC81/6201	G.E.	5.00
ECC88	MULLARD	10.00	6L6WGB	SYLVANIA	15.00	ECC81/CV4024	MULLARD	6.00
ECL82	MULLARD	5.00	6SL7GT	USA	5.00	ECC81/M8162	MULLARD	7.50
ECL86	TUNGSRAM	10.00	6SN7GT	USA	7.50	ECC81/6201 G. PIN	MULLARD	10.00
EF86	USSR	5.00	6V6GT	BRIMAR	7.50	ECC82/CV4003	MULLARD	10.00
EF86	MULLARD	15.00	12AX7WA	SYLVANIA	6.00	ECC82/M8136	MULLARD	12.50
EL34	EI	5.00	12BH7	BRIMAR	12.00			
EL37	MULLARD	30.00	12BY7A	G.E.	7.00			
EL34G	SOVTEK	5.00	211/VT4C	G.E.	85.00			
EL84	USSR	3.00	807	HYTRON	7.50			
EL519	EI	7.50	5687WB	ECG	6.00			
EZ80	MULLARD	5.00	6080	RCA	10.00			
EZ81	MULLARD	7.50	6146B	G.E.	15.00			
GZ32	MULLARD	25.00	6973	RCA	15.00			
GZ33/37	MULLARD	20.00	7027A	G.E.	25.00			
PL509	MULLARD	10.00	7308	SYLVANIA	5.00			
UCH81	MULLARD	3.00	7581A	SYLVANIA	15.00			
UCL82	MULLARD	2.00						

### MANY OTHER BRANDS AVAILABLE

These are a selection from our stock of over 6,000 types. Please call or FAX for an immediate quotation on any types not listed. We are one of the largest distributors of valves in the UK. Same day dispatch. Visa/Mastercard acceptable. Air Post/ Packing (Please Enquire). Obsolete types are our speciality.