

4 C 1,5 CP 8+8Ω

4" | 200 W

Code Z001920

Coaxial

- LF 1,5" voice coil Epotex former
- HF Treated Silk dome 1" voice coil
- DAR** Cloth surround
- LF Ferrite Magnet Circuit
- HF Neodymium Magnet Circuit
- 91.2 dB sensitivity
- Frequency Range 100-18000 Hz

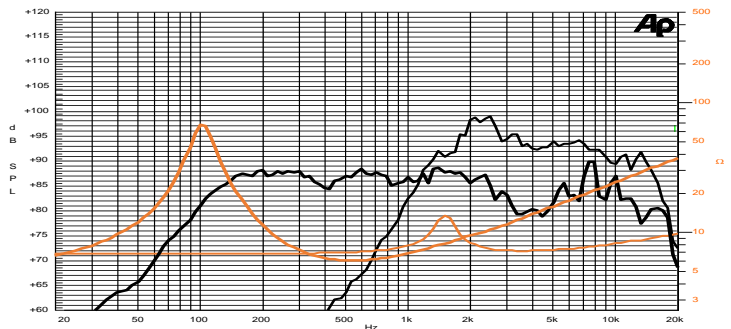
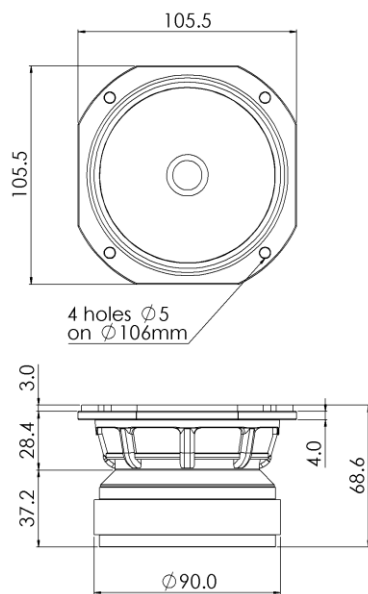

Frequency Response on IEC Baffle (DIN 45575) @ 1W, 1m
Free Air Impedance

General Specifications	LF Unit	HF Unit
Nominal Diameter	106 mm (4")	
Nominal Impedance	8 Ω	8 Ω
Rated Power AES ⁽¹⁾	100 W	
Continuous Program Power ⁽²⁾	200 W	
Sensitivity @ 1W/1m ⁽³⁾	91.2 dB	91.9 dB
Voice Coil Diameter	38 mm (1,5 in)	25 mm (1 in)
Voice Coil Winding Depth	9 mm	1.7 mm
Magnetic Gap Depth	5 mm	2 mm
HF Recomm. Crossover Frequency ⁽⁴⁾	3.0 kHz	
Magnet Weight	405 g	14 g
Net Weight	1.1 kg	

Thiele & Small Parameters⁽⁵⁾

Re (LF)	5.1 Ω	Fs (LF)	102.0 Hz
Re (HF)	6.0 Ω	Fs (HF)	1500 Hz
Qms	4.05	Qes	0.35
Qts	0.32	Mms	5.4 g
Cms	413 μm/N	Bxl	7.27 Tm
Vas	1.5 l	Sd	51.5 cm ²
X max ⁽⁶⁾	+/-2.0 mm	X var ⁽⁷⁾	+/-2.5 mm
η _o	0.51 %	Le (1kHz)	0.35 mH

Constructive Characteristics

Magnet	Ferrite (LF) / Neodymium (HF)
Basket Material	Aluminium Die-Cast
LF Voice Coil Winding/Former Material	Copper / Epotex
HF Voice Coil Winding/Former Material	Copper / Aluminium
LF Cone Material	Surface Treated Paper
HF Dome Material	Treated Silk
Surround Material	Treated Cloth
HF Spare Part Code	Z008955

Mounting Information

Overall Dimension	105.5x105.5 mm
Baffle Cutout Diameter	91 mm
Mounting Holes	4 holes ø5 on ø106 mm
Total Depth	68.6 mm

(1) Rated Power measured with 2-hour test with pink noise signal, 6dB crest factor, loudspeaker in free air, power calculated on rated Zmin. (2) Power on Continuous Program is defined as 3dB greater than the Rated Power. (3) Calculated by Thiele & Small parameters, for SPL average in box refer to frequency response. (4) Minimum crossover frequency, 12dB/oct or higher order high-pass filter. (5) Thiele & Small parameters measured with laser system after preconditioning test. (6) Measured with respect to a THD of 10%. (7) Value corresponding to a decay of the Force Factor, or Compliance, or both, equal to the 50% of the small signal value. (8) Drawing dimensions: mm.

4 C 1,5 CP 8+8Ω

Coaxial

4" | 200 W

Code Z001920

Z001920-TW Polar diagram

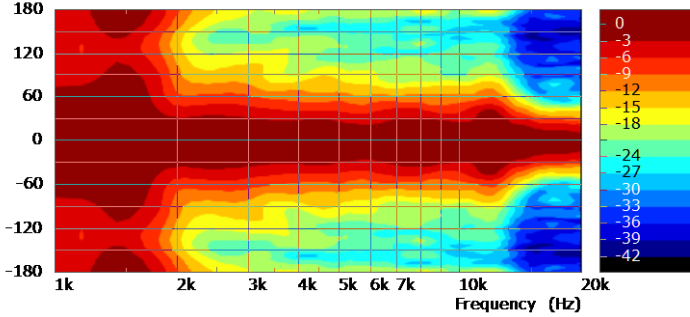

Z001920-TW Polar diagram

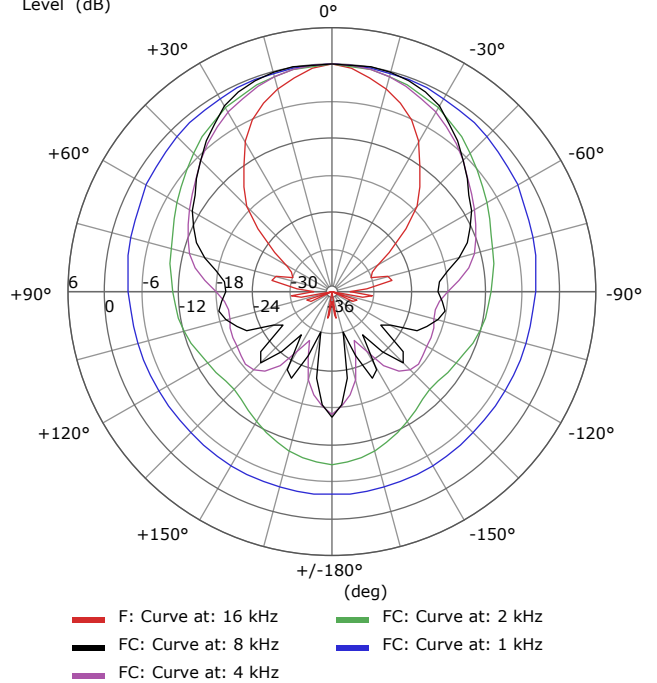

Z001920-W polar diagram

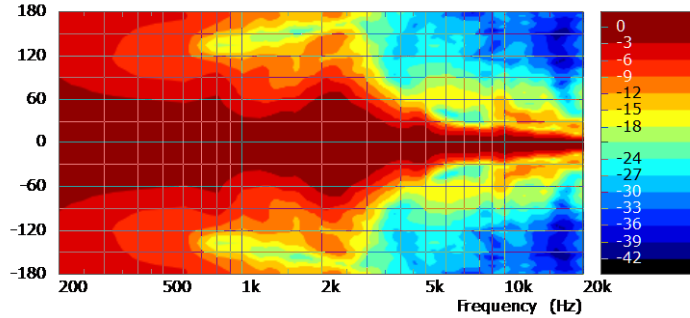

Z001920-W polar diagram

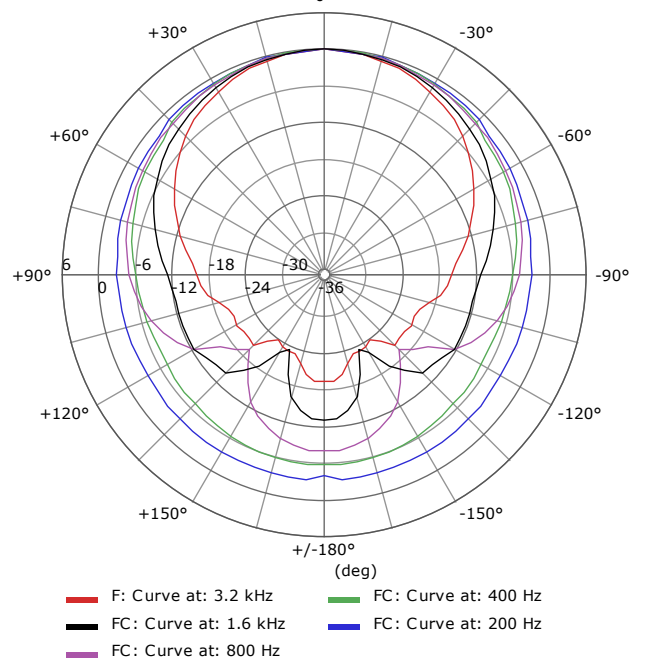

(1) Rated Power measured with 2-hour test with pink noise signal, 6dB crest factor, loudspeaker in free air, power calculated on rated Zmin. (2) Power on Continuous Program is defined as 3dB greater than the Rated Power. (3) Calculated by Thiele & Small parameters, for SPL average in box refer to frequency response. (4) Thiele & Small parameters measured with laser system after preconditioning test. (5) Measured with respect to a THD of 10%. (6) Value corresponding to a decay of the Force Factor, or Compliance, or both, equal to the 50% of the small signal value. (7) Drawing dimensions: mm.

4 C 1,5 CP 8+8Ω

4" | 200 W

Code Z001920

Coaxial

CROSSOVER SUGGESTION

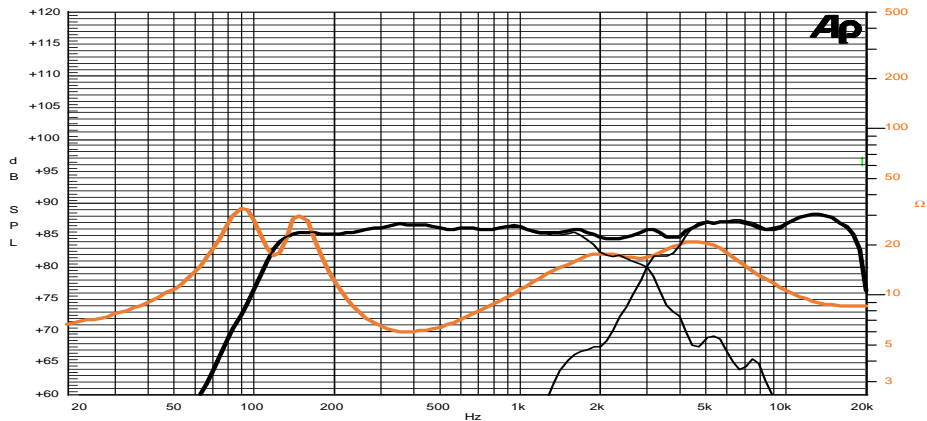
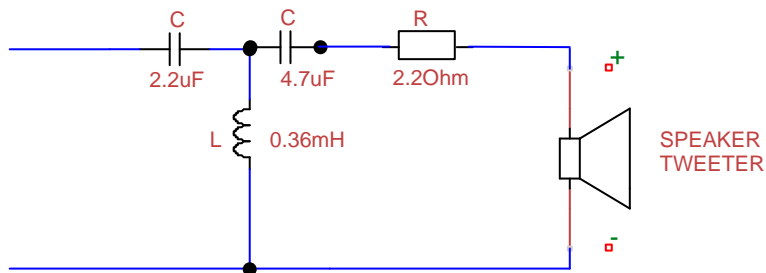
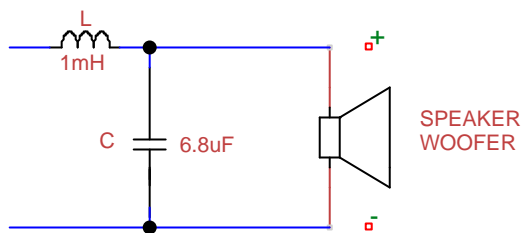

Frequency Response on 2 Lt @ 120 Hz Vented Box @ 1W, 1m
Free Air Impedance

(1) Rated Power measured with 2-hour test with pink noise signal, 6dB crest factor, loudspeaker in free air, power calculated on rated Zmin. (2) Power on Continuous Program is defined as 3dB greater than the Rated Power. (3) Calculated by Thiele & Small parameters, for SPL average in box refer to frequency response. (4) Thiele & Small parameters measured with laser system after preconditioning test. (5) Measured with respect to a THD of 10%. (6) Value corresponding to a decay of the Force Factor, or Compliance, or both, equal to the 50% of the small signal value. (7) Drawing dimensions: mm.