

GENERAL CHARACTERISTICS

Nominal Overall Diameter	268	mm
Nominal Voice Coil Diameter	75	mm
Magnet Weight	360	g
Flux Density.....	1.22	T
Weight.....	3.10	Kg

THIELE-SMALL PARAMETERS

Voice Coil DC Resistance	R_E	5.19	Ω
Resonance Frequency	f_s	53.5	Hz
Mechanical Q Factor.....	Q_{MS}	6.68	
Electrical Q Factor.....	Q_{ES}	0.46	
Total Q Factor	Q_{TS}	0.43	
Mechanical Moving Mass	M_{MS}	37.4	g
Mechanical Compliance	C_{MS}	237	μm/N
Force Factor	$B \times l$	11.87	Wb/m
Equivalent Acoustic Volume.....	V_{AS}	40.1	lt.
Maximum Linear Displacement	X_{MAX}	+/-6.0	mm
Reference Efficiency	η_0	1.27	%
Diaphragm Area	S_D	346.3	cm ²
Losses Electrical Resistance.....	R_{ES}	74.9	Ω
Voice Coil Inductance @ 1kHz	L_E	0.43	mH

CONSTRUCTIVE CHARACTERISTICS

Magnet.....	Neodymium
Voice Coil Winding.....	Aluminium
Voice Coil Former.....	Kapton
Cone	Paper
Surround.....	Treated Cloth
Dust Dome	Solid Paper
Basket	Aluminium Die-Cast

ELECTRICAL CHARACTERISTICS

Nominal Impedance.....	8	Ω
Musical Power	700	W
Rated Power*	350	W
Sensitivity @ 1 W, 1 m	95.1	dB

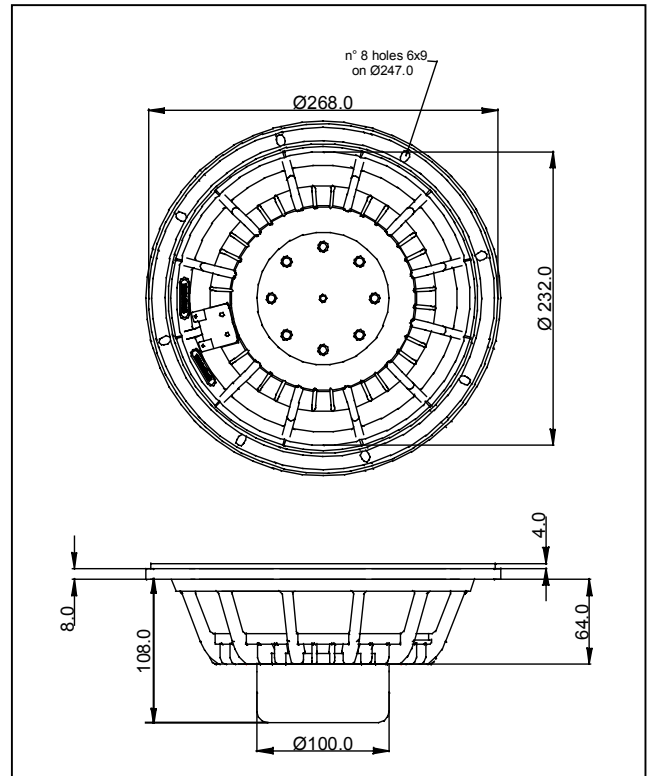

*rated power measured with 2 hours test with pink noise signal, 6 dB crest factor, loudspeaker mounted on enclosure
Thiele-Small parameters measured with LASER system

Frequency Response on IEC Baffle (DIN 45575) @ 1 W, 1 m - Free Air Impedance

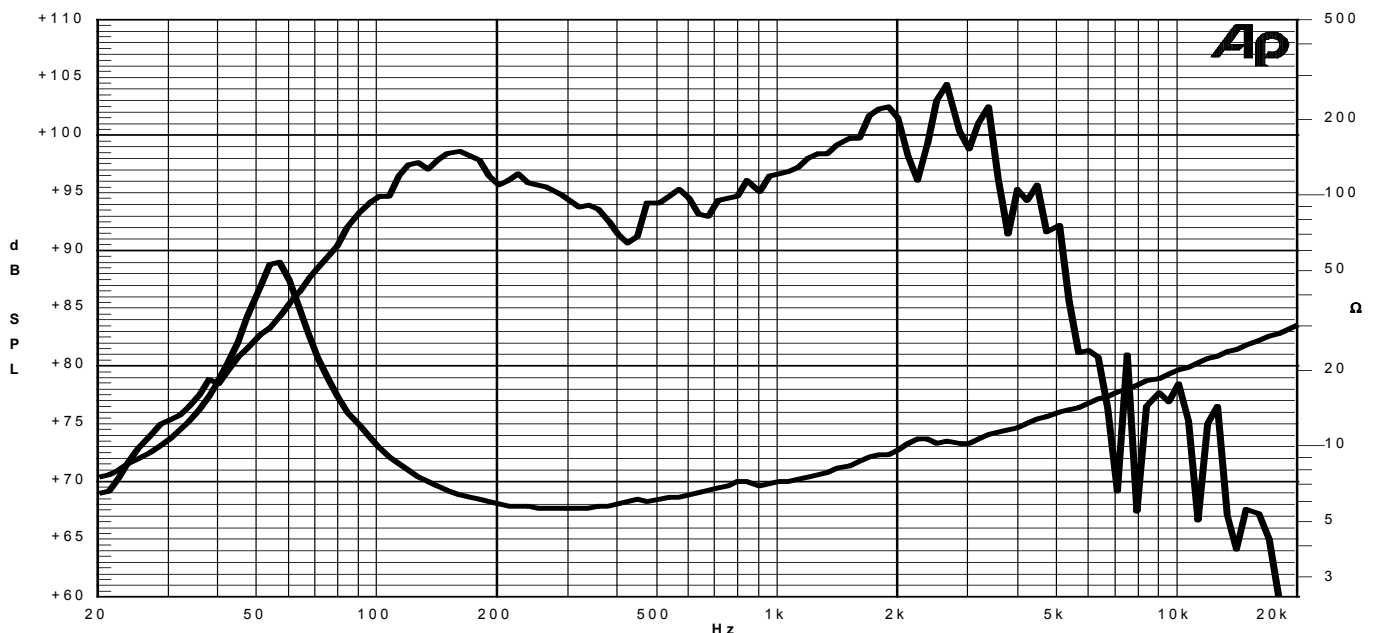

Due to continuing product improvement, the features and the design are subject to change without notice.

04/06/09